

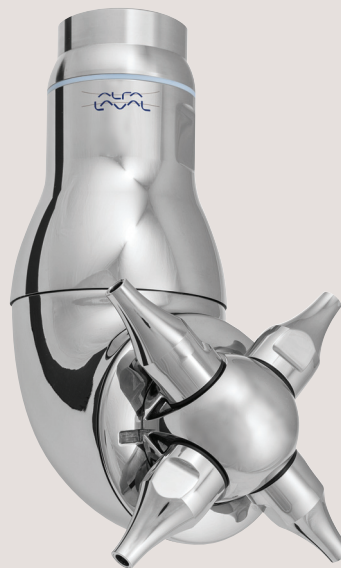

# Instruction Manual

## Alfa Laval TJ40G Rotary Jet Head



Covering: Standard Machines, Heavy duty (HD),  
Q-doc - Equipment Doc (3.1 Inspection Certificate - EN 10204)  
Machines delivered with ATEX/IECEX Certification in accordance with Directive 2014/34/EU  
TE91A725, First published: 2017-01

ESE03480-EN4      2017-09

Original manual



The information herein is correct at the time of issue but may be subject to change without prior notice

<b>1. EU Declaration of conformity</b>	<b>5</b>
<b>2. Safety</b>	<b>6</b>
2.1. Important information	6
2.2. Warning signs	6
<b>3. Introduction</b>	<b>7</b>
3.1. Introduction	7
3.2. Intended use	7
3.3. Patents and trademarks	8
3.4. Marking	8
3.5. ATEX/IECEX marking	9
3.6. ATEX/IECEX temperature class and code	10
3.7. Quality system	10
<b>4. Installation</b>	<b>11</b>
4.1. General description	11
4.2. Functioning	11
4.3. General safety and installation instructions	13
4.4. Specific conditions for safe use in accordance with ATEX/IECEX certification	14
<b>5. Operation</b>	<b>16</b>
5.1. Normal operation	16
5.2. Safety precautions	17
<b>6. Maintenance</b>	<b>18</b>
6.1. Preventive maintenance	18
6.2. Service and repair of ATEX/IECEX certified machines	18
6.3. Maintenance Intervals and service Kits	19
6.4. General assembly/disassembly recommendations	20
6.5. Disassembly tools	20
6.6. Disassembly instructions	21
6.7. Assembly instructions	23
<b>7. Trouble shooting guide</b>	<b>26</b>
<b>8. Technical data</b>	<b>27</b>
8.1. Performance data for TJ40G	28
8.2. Performance data for TJ40G-HD	31
<b>9. Product programme</b>	<b>34</b>
9.1. Standard Configurations	34
9.2. Standard Configurations, Burst	35
9.3. Available Add-ons	36
9.4. Available add-ons for spare parts	36
9.5. Available welding and thread adaptors	37
9.6. Overview of guide and turbine combinations - 4 nozzles	38
9.7. Overview of guide and turbine combinations - 2 nozzles	39
<b>10. Parts drawings, parts lists, service kits and tools</b>	<b>40</b>
10.1. Alfa Laval Toftejorg TJ40G	40
10.2. Alfa Laval Toftejorg TJ40G-HD	42
10.3. Tools	44

## Table of contents

---

*The information herein is correct at the time of issue but may be subject to change without prior notice*

<b>11. General information</b> .....	<b>45</b>
11.1. Service and repair .....	45
11.2. How to order spare parts .....	45
11.3. How to contact Alfa Laval Kolding A/S .....	45
<b>12. Miscellaneous</b> .....	<b>46</b>
12.1. Declaration of Conformity, EN 10474, sub clause 2.2 Test Report .....	46
12.2. Declaration of Compliance with 10/2011 – Food contact materials .....	48

# 1 EU Declaration of conformity

The Designated Company

Alfa Laval Kolding A/S

Company Name

Albuen 31, DK-6000 Kolding, Denmark

Address

+45 79 32 22 00

Phone No.

hereby declare that

Tank Cleaning Machine

Designation

Alfa Laval TJ40G & TJ40G-HD Rotary Jet Head

Type

*From serial number 2016-0001 to 2030-99999*

is in conformity with Machinery Directive 2006/42/EC and the following harmonized standard is used:

*DS/EN ISO 12100:2011 Safety of Machinery - Risk Assessment*

is in conformity with (Ex / ATEX) Directive 2014/34/EU and the following harmonized standards are used:

*EN ISO 80079-36:2016, EN ISO 80079-37:2016, DS/EN ISO/IEC 80079-34:2011, Annex A, paragraph A.5.3 Rotating machines*

*EC Type Examination Certificate no. Baseefa17ATEX0018X and IECEx BAS 17.0017X*

Marking:  II 1G Ex h IIC 85°C... 175°C Ga  
II 1D Ex h IIC T85°C... T140°C Da

*Baseefa Ltd., Certification body number 1180, Rockhead Business Park, Staden Lane, Buxton, Derbyshire SK17 9RZ, United Kingdom*

The person authorised to compile the technical file is the signer of this document.

Global Product Quality Manager  
Pumps, Valves, Fittings and Tank Equipment

Title

Lars Kruse Andersen

Name



Signature

Kolding

Place

2017-09-01

Date

*This Declaration of Conformity replaces Declaration of Conformity dated 2017-03-01*



## 2 Safety

---

*Unsafe practices and other important information are emphasized in this manual.*

*Warnings are emphasized by means of special signs.*

***Always read the manual before using the tank cleaning machine!***

---

### 2.1 Important information

---

#### **WARNING**

Indicates that special procedures must be followed to avoid serious personal injury.

#### **CAUTION**

Indicates that special procedures must be followed to avoid damage to the tank cleaning machine

#### **NOTE**

Indicates important information to simplify or clarify procedures.

---

### 2.2 Warning signs

---

General warning:



ATEX/IECEx warning



### 3.1 Introduction

Based on more than 30 years' experience from practical tank cleaning and production, the Alfa Laval Toftejorg TJ40G Rotary Jet Head has been developed to meet the highest demands for efficiency, reliability and hygiene within food and beverage, pharmaceutical and biochemical industry.

This manual has been prepared as a guide for installing, operating and maintaining your Alfa Laval Toftejorg tank cleaning machine. Should you require further assistance, our Technical Sales Support department and worldwide net of sales offices are pleased to help you. Please quote the type, article and serial numbers with all of your enquiries; this helps us to help you. The type and serial number are placed on the body of the tank cleaning machine.

Get the best and most economical performance from your tank cleaning machine. Insufficient preventive maintenance means poor performance, unscheduled stops, shorter lifetime and extra costs. On the contrary, good preventive maintenance on the contrary means good performance, no unscheduled stops and superior total economy.

If the Alfa Laval Toftejorg TJ40G stops rotating unintentionally within the warranty period, please return the machine to Alfa Laval. Please do not try to fix any mechanical problems before shipping.

**Important information:**



Before installing the machine and setting it into operation, carefully read the General safety and installation instructions (page 13) and the specific conditions for safe use in accordance with ATEX/IECEX directive 2014/34/EU (page 14) and take all necessary precautions according to your application and local regulations.

#### NOTE

The illustrations and specifications contained in this manual were effective at the date of printing. However, as continuous improvements are our policy, we reserve the right to alter or modify any unit specification on any product without prior notice or any obligation.

The English version of the instruction manual is the original manual. We make reservations in regard to possible mistranslations in language versions of the instruction manual. In case of doubt, the English version of the instruction manual applies.

### 3.2 Intended use

The end-user should verify:

- that the tank cleaning machine is in conformity with respect to tank, vessel or container size in which it is used.
- that the construction materials (both metallic and non-metallic) are compatibility with product, flushing media, cleaning media, temperatures and pressure under the intended use.

The tank cleaning machine is intended for use in closed tank, vessel or container. If used in open environment see 4.3 General safety and installation instructions (page 13).

## 3 Introduction

TJ40G

### 3.3 Patents and trademarks

This Instruction Manual is published by Alfa Laval without any warranty. Improvements and changes to this Instruction Manual may at any time be made by Alfa Laval without prior notice. Such changes are incorporated in new editions of this Instruction Manual.

Alfa Laval Kolding A/S. All rights reserved.

The Alfa Laval logotype is a trademark or a registered trademark of Alfa Laval Corporate AB. "Toftejorg" is a trademark or registered trademark of Alfa Laval. The Alfa Laval Toftejorg™ TJ40G product has a pending patent in the EPO member states (EP 14199732.0), in the US and in other countries. Other products or company names mentioned herein may be the trademarks of their respective owners. Any rights not expressly granted herein are reserved.

### 3.4 Marking

Alfa Laval tank cleaning machines are marked to allow for recognition of type of machine, machine name, serial number and manufacturing address.

The marking is placed on the body of the tank cleaning machine.

Rotary Jet Head

TJ40G

s/n.: yyyy-xxxxx

Alfa Laval, DK-6000 Kolding, Albuen 31



#### Serial number explanation

Machines supplied with or without normal documentation:

yyyy-xxxxx: serial number

yyyy: year

xxxxx: 5 digit sequential number

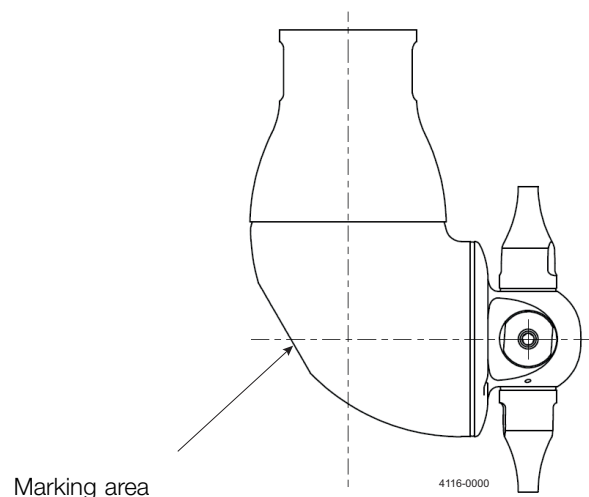



TJ40G

---

### 3.5 ATEX/IECEX marking

---

The Alfa Laval Toftejorg TJ40G is certified as category I component. The certification is carried out by the notified body Baseefa, who has issued the certificate no. 17ATEX0018X and IECEX BAS 17.0017X.

#### Note

Explosion protection type is constructional safety “c”.

The marking on the ATEX/IECEX certified Alfa Laval Toftejorg TJ40G is as follows:

Rotary Jet Head  
TJ40G  
s/n.: yyyy-xxxxx



Alfa Laval, DK-6000 Kolding, Albuen 31  
II 1G Ex h IIC 85°C...175°C Ga  
II 1D Ex h IIIC T85°C...T140°C Da  
1180 Baseefa 17ATEX0018X IECEX BAS 17.0017X

#### Serial number explanation:

Machines supplied with or without normal documentation:

yyyy-xxxxx: serial number

yyyy: year

xxxxx: 5 digit sequential number

---

### 3 Introduction

TJ40G

#### 3.6 ATEX/IECEx temperature class and code

The maximum surface temperature depends mainly on operating conditions which are the temperature of the process fluid and the ambient temperature.

##### Group II EPL Ga

The gas temperature class is corrected with a safety margin of 80% due to a requirement for Group II EPL Ga equipment. The gas temperature class depends on the process fluid temperature or the ambient temperature, whichever of the two is the highest.

Table for determining temperature class (gas atmospheres)		
Temperature Class	Process fluid Temperature, $T_p$ (°C)	Ambient temperature, $T_{amb}$ (°C)
85°C (T6)	$\leq +68^\circ\text{C}$	$\leq +68^\circ\text{C}$
100°C (T5)	$\leq +80^\circ\text{C}$	$\leq +80^\circ\text{C}$
135°C (T4)	$\leq +108^\circ\text{C}$	$\leq +108^\circ\text{C}$
175°C	$\leq +140^\circ\text{C}$	$\leq +140^\circ\text{C}$

##### Group III EPL Da

The dust temperature class depends on the process fluid temperature or the ambient temperature, whichever of the two is the highest.  
No dust layer is considered.

Table for determining temperature class (dust atmospheres)		
Temperature code	Process fluid temperature, $T_p$ (°C)	Ambient temperature, $T_{amb}$ (°C)
T85°C	$\leq +85^\circ\text{C}$	$\leq +85^\circ\text{C}$
T100°C	$\leq +100^\circ\text{C}$	$\leq +100^\circ\text{C}$
T135°C	$\leq +135^\circ\text{C}$	$\leq +135^\circ\text{C}$
T140°C	$\leq +140^\circ\text{C}$	$\leq +140^\circ\text{C}$

Example of gas class determination

Process fluid temperature is 67°C and ambient temperature is 75°C.  
Gas class = T5

ATEX/IECEx marking on the equipment:



II 1G Ex h IIC 85°C...175°C Ga  
II 1D Ex h IIC T85°C...T140°C Da

#### 3.7 Quality system

The Alfa Laval Toftejorg TJ40G is designed to be best-in-class on hygienic design using recognised principles of hygienic design wherever feasible. It is produced according to Alfa Laval Kolding's ISO-9001 international Standard certified quality system. All parts are made from certified material and all non-metal parts are made from FDA and EU 10/2011 complaint materials.

## 4.1 General description

The Alfa Laval Toftejorg TJ40G is a media driven and media lubricated tank cleaning machine. No lubricating substances such as oil, grease etc. are used. All materials are selected for contact with food, and the machine is self-cleaning i.e. all internal and external surfaces are cleaned during normal operation.

For use in explosive hazard zones the ATEX/IECEx version can be used, provided it is installed according to safety instructions in local regulations.

## 4.2 Functioning

The flow of cleaning fluid into the machine passes through a turbine, which accordingly is set into rotation. Through a gear set, the turbine rotation is transmitted to the cleaner head.

The combined motion of the machine body and the nozzles ensures a fully indexed tank cleaning coverage. After  $5 \frac{5}{8}$  revolutions of the hub cover with nozzles ( $5 \frac{3}{8}$  revolutions of the machine body), one coarse cleaning pattern is laid out on the tank surface and the first cycle has been made. During the following cycles, this pattern is repeated 7 times, each of which is displaced, and the pattern gradually becomes more dense. Finally, after 8 cycles - a total of 45 revolutions of the hub cover with nozzles (43 revolutions of the machine body), a complete cleaning pattern has been laid out, and the first pattern is repeated (figure 1).

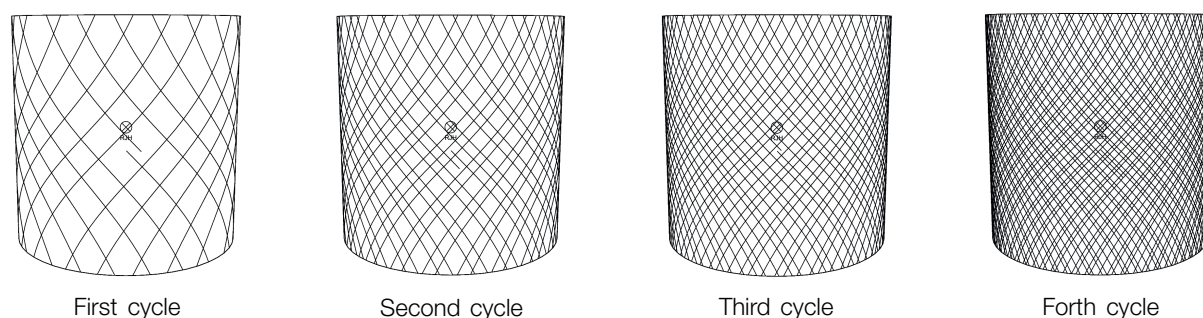

Figure 1: Build up of pattern for cylindrical tank with the machine placed in the centre

The number of cycles needed to perform a proper cleaning depends on type of soilage, position of the tank cleaning machine, cleaning procedure, cleaning temperature and cleaning agent.

For substances that are easily mobilised, i.e. are easy to remove, one cycle could be sufficient while in cases of more heavy soilage (high viscous, sticky substances, etc.) a more dense pattern (more cycles) are needed.

The rotation speed of the turbine depends on the flow rate through the machine. The higher the flow rate, the higher the speed of rotation. In order to control the RPM of the machine for a wide range of flow rates, the machine has different turbines according to the nozzle size.

## 4 Installation

TJ40G

Apart from the main flow flushing the gear and the hub, and thereafter forming the jets through the nozzles, fluid is flushed through all internal areas, through bevel gear, ball bearings and gaps between moving parts and finally also used for cleaning of the outside surfaces of the machine. In the bottom of the body, a drain hole is present to ensure self-draining. This self-draining is only ensured, if the machine is installed in upright position.

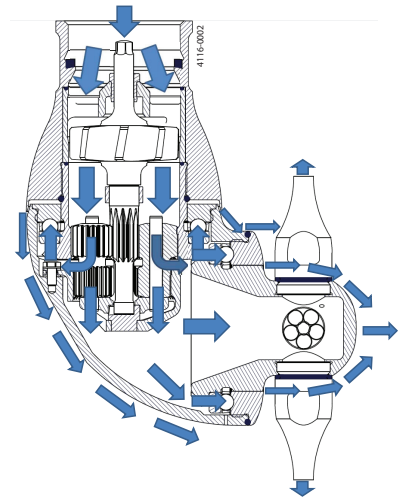

The cone is cleaned from the patent pending design of the hub; this is by impact and sheeting action.

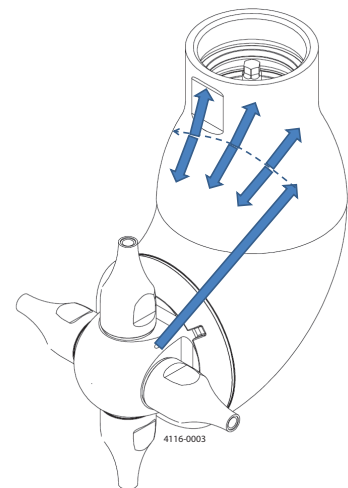

The threaded connection between downpipe and machine is not a product contact surface as it is enclosed using two seals and the welding adaptor. If needed, a welding adaptor, depending on downpipe dimensions, must be ordered separately (see page 37ff).

For all versions:  
For devices with tapered thread connections to the down pipe, it is recommended that you secure the connection in a manner appropriate for the application. Subject to the intended use environment and any inhouse user requirements or policies, an adhesive such as Loctite No. 2046 or equivalent could be used. Other methods could be acceptable and subject to customer preference.

- A: Down pipe
- B: Welding adaptor
- C: Seal PTFE
- D: Seal EPDM

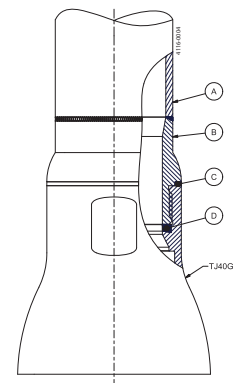

### 4.3 General safety and installation instructions

During handling and installation handle the machine with care in order not to damage the surface finish of the machine.

Upon arrival check that the machine is in operating condition using an 8 mm socket wrench on the turbine shaft and easily turn the turbine shaft anti-clockwise. If resistance is recognized, disassembled the machine to localize the cause.

#### NOTE

Do not try to turn the hub with hub nozzles by hand, since this may damage the gear. The hub with nozzles can be turned by blowing compressed air through the inlet connection or using a socket wrench on top of the turbine shaft.

Before connecting the machine to the system, all supply lines and valves should be flushed for removal of foreign particles.

The tank cleaning machine should be installed in vertical position (upright or upside down). The installation and operation shall be made so that the self-draining of the machine is ensured.

The machine should be screwed tightly onto the supply line using a 65 mm flat jawed spanner (tool No. TE81B147) on the flats, machined on the inlet cone. Subject to the environment of intended use and any in-house user requirements or policies adhesives such as Loctite no. 2046 could be used to prevent the connection from loosening due to excessive vibration in the system.

In order to separate the CIP system from the process it is recommended to install a shutoff valve close to the machine inlet. This also prevents back-flow of liquid from the tank through the machine in case the machine is submerged and there is an over-pressure inside the tank.

It is recommended that the fluid valve fitted is of a type that prevents hydraulic shocks. Hydraulic shocks may cause severe damage to the machine and/or the entire installation. Ideally, use a frequency controlled pump with a ramp function for start-up to supply the cleaning liquid.

Larger particles may get trapped in the nozzles, while smaller particles may be get trapped in the smaller clearances of the machine and increase wear. Magnitude of the issues relies on the particle shape and properties (e.g. soft vs. hard). Experience shows that Alfa Laval tank cleaning machines may operate with strainer sizes larger than recommended below. Contact your local Alfa Laval office for support.

For low amounts of particles in the recirculating CIP liquid larger particles should be avoided and in this case a 3 mm strainer may be sufficient for a reliable operation.

For high amounts of particles in the recirculating CIP liquid it is recommended to install a strainer according to the smallest clearance in the machines. For the TJ40G a strainer of 0.1 mm is recommended and for the TJ40G-HD a strainer of 1 mm is recommended.

The machine shall be installed in accordance with national regulations for safety and other relevant regulations and standards. Precautions shall be made to prevent starting of the cleaning operation, while personnel are inside the tank or otherwise can be hit by jets from the nozzles. In EU-countries the complete system must fulfil the EU-machine Directive and depending of application, the EU-Pressure Equipment Directive, the EU-ATEX/IECEx Directive and other relevant Directives and shall be CE-marked before it is set into operation.

**Warning:**



Precautions shall be made to prevent starting of the cleaning operation, while personnel are inside the tank or otherwise can be hit by jets from the nozzles.

For information on use in potential explosive atmospheres see paragraph 4.4 Specific conditions for safe use in accordance with ATEX/IECEx certification page 14.

## 4 Installation

TJ40G

### 4.4 Specific conditions for safe use in accordance with ATEX/IECEx certification

Directive 2014/34/EU

**NOTE**

Explosion protection type is constructional safety “c”.

**Warning: Temperature class and ambient temperature range**



The temperature class and ambient temperature range are shown in paragraph 3.6 ATEX/IECEx temperature class and code, page 10.

**Warning: Surface temperature**



The maximum surface temperature depends mainly on operations conditions which is the temperature of the process fluid and ambient temperature, see paragraph 3.6 ATEX/IECEx temperature class and code, page 10.

**Warning: Draining using compressed air**



Draining using compressed air must not be done in ex classified zone.  
Draining using compressed air is possible in non ex classified zones (see page 16).

**Warning: Earthing**



All metal and other conductive or dissipative material should be connected to earth with the exception of very small items.  
For further information see IEC/TS 60079-32-1:2013 Explosive atmospheres – Part 32-1: Electrostatic hazards, guidance. With focus on clause 6.2.3, 7.2.1, 7.3, 7.9.2, 13.

**Warning: Steaming tanks greater than 100 m<sup>3</sup>**



Tanks with capacities greater than 100 m<sup>3</sup> that could contain a flammable atmosphere should not be steam cleaned, as steam cleaning tanks produces an electrostatically charged mist. Tanks smaller than 100 m<sup>3</sup> may be steam cleaned. For further information see IEC/TS 60079-32-1:2013 Explosive atmospheres – Part 32-1: Electrostatic hazards, guidance. With focus on clause 7.10 and 8.5.

**Warning: Earthed when in use**



The unit must be effectively earthed at all times when in use.

**Warning: Process generated electrostatic**



The user must address the electrostatic hazards generated from the process of the equipment in accordance with guidance document IEC/TS 60079-32-1:2013.

**Warning: Electrostatically charged liquid**

Liquids can become electrostatically charged when they move relative to contacting solids or the spraying of liquids can also create a highly charged mist or spray. The cleaning solvent must be made electrically conductive by additives or otherwise.

For further information see IEC/TS 60079-32-1:2013 Explosive atmospheres – Part 32-1: Electrostatic hazards, guidance. With focus on clause 7.1.3, 7.1.4, 7.2.1, 7.2.4.

**NOTE**

The tank cleaning machine has been certified by accredited notified body and can operate in tanks having an enclosed volume up to 100 m<sup>3</sup> as long as all ATEX warnings in the instruction manual are complied with.

**General guidelines for tanks larger than 100 m<sup>3</sup>:**

Tanks larger than 100 m<sup>3</sup> must not be steam cleaned – See guide IEC/TS 60079-32-1:2013 clause 8.5.

To use the unit in tanks larger than 100m<sup>3</sup> is possible under certain conditions.

It is necessary to know the current factors such as tank size, cleaning solvent and product.

Additives can be used in the cleaning solvent, or, for example, the tank can be filled with nitrogen. The basic guidelines are described in the guide IEC/TS 60079-32-1:2013.

It must be ensured that the equipotential bonding of all conductive metal objects is in accordance with national regulations for use.

The process fluid conductivity must correspond to the products in the group “High conductivity”, cf. IEC/TS 60079-32-1:2013 clause 7.1 and 7.2.

High conductivity	> 10 000 pS/m
Medium conductivity	between 25 × εr pS/m and 10 000 pS/m
Low conductivity	< 25 × εr pS/m

For liquids with a dielectric constant of around 2, (e.g. hydrocarbons), these classifications reduce to:

High conductivity	> 10 000 pS/m
Medium conductivity	between 50 pS/m and 10 000 pS/m
Low conductivity	< 50 pS/m

Following a guidance document such as IEC/TS 60079-32-1:2013 to establish safe use of machinery and process is the users own responsibility and is not covered by the ATEX/IECEx certification for this unit except for tanks up to 100 m<sup>3</sup>. For further information see IEC/TS 60079-32-1:2013 Explosive atmospheres – Part 32-1: Electrostatic hazards, guidance with focus on clause 7.1.3, 7.1.4, 7.2.1, 7.2.4.

**Warning: Appropriate cleaning fluid**

The cleaning fluid should be appropriate for the application (e.g. so no chemical reaction can take place between the cleaning fluid and the residue of process fluid/compound which can generate heat).

**Warning: Fluid pressure**

The maximum permitted process fluid pressure is 12 bar.

In addition to the above mentioned precautions relating to Directive 2014/34/EU, the Safety Precautions on page 13 must be observed.

## 5 Operation

TJ40G

### 5.1 Normal operation

#### Cleaning Media

Use only media compatible with Stainless Steel AISI 316, SAF 2205, PEEK, PFA HP and EPDM. Normal detergents, moderate solutions of acids and alkalis are acceptable. Aggressive chemicals, excessive concentrations of chemicals at elevated temperatures, as well as certain hypochlorides should be avoided. If in doubt, contact your local Alfa Laval sales office.

#### NOTE

Do not try to turn the hub with nozzles by hand, since this may damage the gear. The hub with nozzles can be turned by blowing compressed air through the inlet connection or by using a socket wrench on top of the turbine shaft.

PEEK is not resistant to concentrated sulphuric acid.

#### Product

In cases where the machine is submerged in, or in other ways exposed to, product the compatibility between stainless steel AISI 316, SAF 2205, PEEK, PFA HP and EPDM and the product must be considered carefully.

#### NOTE

EPDM swells significantly exposed to fatty materials.

#### Pressure

Avoid hydraulic shocks. Increase pressure gradually. Do not exceed 12 bar inlet pressure. Recommended inlet pressure: 5-7 bar. High pressure in combination with high flow rate increase consumption of wear parts. High pressure also reduces the cleaning effect.

#### Draining using compressed air

If the machine is drained using compressed air, then the compressed air pressure must not cause the machine body rotation to exceed 4.5 rpm (corresponding to appx. 13 sec pr. rev of the body) in order to avoid risk of machine breakdown.

Draining should always be done inside the tank.

See paragraph 4.4 Specific conditions for safe use in accordance with ATEX/IECEX certification (page 14).

#### Steam cleaning

If steam cleaning is done through the machine, the steam pressure must not cause the machine body rotation to exceed 10 rpm (corresponding to appx. 6 sec pr. rev of the body) in order to avoid risk of machine breakdown. See paragraph 4.4 Specific conditions for safe use in accordance with ATEX/IECEX certification (page 14).



TJ40G

### Temperature

The maximum recommended process liquid temperature is 95°C. The maximum recommended steam temperature is 140°C. The maximum ambient temperature is 140°C.

See paragraph 4.4 Specific conditions for safe use in accordance with ATEX/IECEx certification (page 14).

### After use cleaning

After use flush the machine with fresh water. Cleaning media should never allow to dry or settle in the system due to possible "salting out" or "scaling" of the cleaning media. If cleaning media contains volatile chloride solvents, it is recommended **not to flush with water** after use, as this might create hydrochloric acid.

## 5.2 Safety precautions

The machine is intended for use inside a tank only. As peak velocity of main jets reaches 40 m/s, The Alfa Laval Tofteborg TJ40G must not be operated in open air or when tank is open.

### Warning:



Hot chemicals and steam under pressure may be used for cleaning and sterilising. Protect against scalding and burning. Never tamper with or try to open clamps or other connections while system is in operation. Make sure that system is de-pressurised and drained before disassembly.

The cleaning jets impinging the tank surface are a source of noise. Depending on pressure and distance to the tank walls, noise level may reach up to 85 dB.

### Warning:



Tanks may contain poisonous/hazardous products or products which represent an environmental or safety risk. Never open tank and dismount the machine without checking previous tank contents and necessary precautions.

See also 3.6 ATEX/IECEx temperature class and code, page 10.

## 6 Maintenance

TJ40G

### 6.1 Preventive maintenance

Following the Alfa Laval Preventive Maintenance Guidelines and using the Alfa Laval Service Kits ensures the availability of your equipment at all times and enables you to plan your operating budget and your downtime. The risk of unscheduled breakdowns due to component failure is virtually eliminated and in the long term your operating costs are reduced.

Alfa Laval Tank Cleaning Equipment Service Kits contain all you need. They comprise genuine, traceable Alfa Laval spare parts, manufactured to the original specifications.

The recommended preventive maintenance program is based on tank cleaning machines working in average conditions. However, a tank cleaning machine, exposed to heavy soiling and recirculation CIP liquid containing abrasives and/or particulates (see section 4.3 General safety and installation instructions for strainer recommendations), needs more frequent attention than one exposed to light/no soiling and recirculation with ordinary CIP liquid. Alfa Laval Kolding A/S recommends that you adjust the maintenance program to suit the cleaning task in hand. Contact your local Alfa Laval sales office for discussion.

For further information regarding Alfa Laval Service Kits and service intervals, see paragraph 6.3 Maintenance Intervals and service Kits on page 19 of this manual or the Spare Parts Manual.

#### NOTE

Handle the Alfa Laval Toftejorg machine with care. Take proper action to protect surfaces from being damaged.

Always use only proper tools and the Alfa Laval Toftejorg TJ40G standard tool kit (page 20). Never use force, hammer or pry components together or apart. Always perform all assembly/disassembly steps in the order described in this manual.

Clean all surfaces prior to assembling. Especially take care of the mating surfaces. Work in a clear well-lighted work area.

According to "Regulation (EC) No 1935/2004 - Article 17" effective from 27th of October 2006, producers of food shall ensure traceability of the materials and articles intended to come into contact with foodstuffs. It is recommended that a traceability system is setup for replacement of wear parts and spare parts. This makes it possible to identify into which machine a given wear part or spare part has been inserted.

### 6.2 Service and repair of ATEX/IECEx certified machines

All service and repair of ATEX/IECEx certified machines can be performed by Alfa Laval Kolding A/S, Denmark, or by an Alfa Laval service center approved by Alfa Laval Kolding A/S.

Changes to the machine are not allowed without approval by the person responsible for the ATEX/IECEx certification at Alfa Laval. If changes are made – or spare parts other than Alfa Laval original spare parts are used - the EC Type Examination certification (the ATEX/IECEx Directive) is no longer valid.

#### Warning:



In order to ensure compliance with the ATEX/IECEx regulations and keep the machine ATEX/IECEx certification valid the service or repair must be performed by an authorized person with knowledge of the ATEX/IECEx requirements and regulations.

All spare parts must be original Alfa Laval spare parts and the repair or service must be done according to the instructions in the related manual.

If a customer wishes to carry out service or repair himself, it is the responsibility of the repair shop to ensure that the ATEX/IECEx requirements are met in any way possible. After performing service or repair, the repair shop thus carries the full responsibility for traceability of all relevant documents in order to ensuring the retention of the ATEX/IECEx certification of the machine.

### 6.3 Maintenance Intervals and service Kits

It is recommended that the wear parts are checked every 500 working hours for machine working under normal conditions. There are Minor and Major service kits for the Alfa Laval Toftejorg TJ40G (see parts lists and drawings page 40 ff).

#### Service intervals

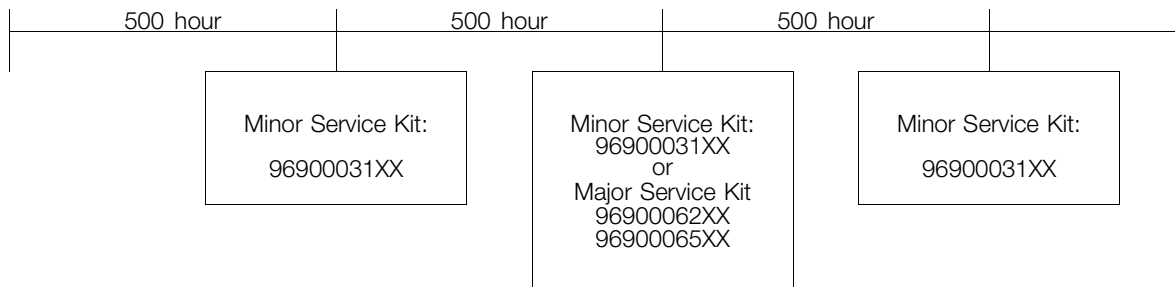

#### Every 500 working hours

(#) refers to position numbers on page 40.

1. Disassemble machine as described on the following pages.
2. Clean material build-up and deposits from internal parts with Scotch-brite, S-Ultra-fine, eventually chemical media and fine abrasive cloth.
3. Check bearing for body (9) for wear. If the hole is worn oval to a max. diameter of more than 10.4 mm, it should be replaced.
4. Check bearing for turbine shaft top (26) in cone. If hole is worn oval to a max. diameter of more than 10.4 mm, Bearing should be replaced. If the bearing is loose in a horizontal direction, the bearing should be replaced.
5. Check planet gear carrier bearing (17). If worn oval to a max. diameter of more than 15.3 mm, it should be replaced.

**Note:** Timely replacement of bearings prevents costly damage to the gearbox.

6. Check gear wheels (15 and 16). They must rotate easily on the shafts. If restriction or too much clearance on shafts is felt, planet wheels should be dismounted for inspection of bearing surfaces and shafts for planet wheel (14). Max diameter of holes: 6.8 mm. Check tooth wear. **If replacement is necessary, planet wheels must be replaced as a pair.**
7. Check unrestricted rotation of ball bearings. Inspect for build-up of foreign material on stem nut (12) and hub nut (6), in ball retainers (5) and ball races (4).
8. Inspect the nozzle vanes (28) for foreign objects (e.g. product pulp, threads, etc.) and if necessary clean with care – damaging nozzles (or fouled nozzles) decrease the throw length of the machine. Clean using compressed air or tweezers.
9. Replace gaskets if damaged.
10. Check if ball races (5) on stem and hub (3) as well as stem/hub nut w. ball race (12 and 6): If heavily worn, they should be replaced. Also the ball retainer w. balls (5) should be replaced if heavily worn.
11. Assemble machine as described in the following pages.
12. Check that the hub (3) is not stuck on hub nut - it should be possible to shift hub (3) a little both clockwise and anticlockwise.
13. Check that the machine is in operating condition by using a socket wrench (8 mm) on top of turbine shaft, and easily turn turbine shaft anticlockwise. If resistance is recognised, disassembled machine in order to localise the cause.

Apart from the parts specifically mentioned above, all the remaining wear parts should regularly be inspected for wear. Which parts that are wear parts appear from the Spare Part Manual, available from the on-line Alfa Laval product catalogue Anytime or the Close at hand spare part catalogue.

## 6 Maintenance

---

TJ40G

---

### 6.4 General assembly/disassembly recommendations

---

- Always read the instruction and maintenance manuals carefully before service.
- Always replace all parts included in the Service Kit.
- Prior to assembly/disassembly clean all tools and fixtures to ensure that scratches and marks and trace of soil/corrosion from tools are avoided.
- Do not scratch or damage the surfaces of the machine.
  - Always place components on soft material

Check surfaces for product residues and clean all parts before assembly. Assembly of the machine is described on the following pages.

---

### 6.5 Disassembly tools

---

#### Disassembly tools needed for maintenance and repair

(For toolkit see page 44).

- Caliper
- Fork key NV65
- Fork key NV24
- Pin punch  $\varnothing 8$  mm
- Extended socket wrench  $\varnothing 8$  mm
- Torque wrench
- Support ring (only for changing ball races) - e.g. a piece of pipe with an inner diameter of  $\varnothing 67$  -  $\varnothing 80$
- Bench vice (large enough to secure the body of the TJ40G)
- Rubber hammer

#### Special tool needed for disassembly turbine assembly

- Fixture for impeller

#### Standard toolkit

- Item no. TE81B149 (see page 44)
-

## 6.6 Disassembly instructions

**Warning:**

During disassembly and assembly the threads can gall. If any resistance is felt when screwing/unscrewing parts, proceed with caution.

(#) refers to position numbers on page 40.

**Step 1**

Remove the four nozzles (27) using fork key NV24.

a. If damaged remove O-rings (29) from nozzles (27).

**Step 2**

Fasten the machine in a bench vice using the surfaces where the nozzles (27) are attached to the machine.

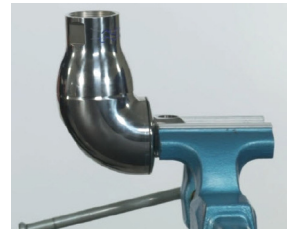
**Step 3**

Using a socket wrench (ø8 mm) on the top of the turbine to rotate the turbine shaft until the machine is more-or-less in vertical position (by hand support the body (1) of the machine to aid the rotation).

**Step 4**

If damaged remove gasket (30) from inside the cone (24).

**Step 5**

Loosen and remove cone (24) using fork key NV65.

**Step 6**

Remove guide (25), turbine assembly and planet gear assembly. NB: guide maybe inside cone when removing the cone.

- a. If damaged remove O-ring (22) from the guide.
- b. If worn too much remove bearing (26) from guide using drift punch.
- c. If worn too much or if gear wheels (15 and 16) need to be inspected remove bushing (17) from planet gear frame (13).
  - i. Remove gear wheels (15 and 16) from planet gear frame (13).
- d. If O-rings (20) on turbine assembly needs replacement disassemble it.
  - i: Mount fixture (TE20J591) in bench vise.
  - ii: Insert impeller shaft (18) end of assembly into fixture (TE20J591).
  - iii: Loosen shaft end (21) of assembly using socket wrench (ø8 mm).
  - iv: Remove impeller (19).
  - v: Remove O-ring (20) from impeller (19).

**Step 7**

Remove O-ring (22) from stem (11).

**Step 8**

Remove O-ring (23) from stem (11).

**Step 9**

Loosen stem nut (12) using caliper. If needed use rubber hammer on caliper.

## 6 Maintenance

---

TJ40G

---

### Step 10

Remove stem (11) along with ball retainer w. balls (5) and stem nut (12) from the machine.

- a. Remove stem nut (12) from stem (11).
  - b. Remove ball retainer w. balls (5) from stem (11).
  - c. If worn remove ball race (4) from stem (11) using pin punch to pry it loose.
- 

### Step 11

Loosen the 3 screws (10) attaching the gear ring (7) to the machine.

---

### Step 12

Remove the gear ring (7).

- a. If worn too much remove bearing (9) from gear ring (7) using pin punch.
- 

### Step 13

Remove the machine from the bench vise.

---

### Step 14

Hold body (1) against table and loosen hub nut (6) using caliper. If needed use rubber hammer on caliper.

<b>Note:</b> Left-hand thread
-------------------------------

**NB:** Body (1) can also be fixed in bench vise, but care should be taken a) not to damage the outside surface roughness and b) not apply too much pressure from the jaws to the body (1) as this can deform the body.

### Step 15

Remove hub (3) along with ball retainer w. balls (5) and hub nut (6) from the machine.

- a. Remove O-ring (2) from body (1).
  - b. Remove hub nut (6) from hub (3).
  - c. Remove ball retainer w. balls (5) from hub (3).
  - d. If worn remove ball race (4) from hub (3) using pin punch to pry it loose.
-

---

## 6.7 Assembly instructions

---

**Warning:**

During disassembly and assembly the threads can gall. If any resistance is felt when screwing/unscrewing parts, proceed with caution.

(#) refers to position numbers on page 40.

Before assembly make sure that all parts are clean without deposits or build-up of foreign matter.

Inspect the nozzle vanes (28) for foreign objects (e.g. product pulp, threads, etc.) and if necessary clean with care - damaging nozzles (or fouled nozzles) decreases the throw length of the machine. Clean using compressed air or tweezers.

### Planet gear assembly (if it has been disassembled)

**Step 1**

Put gear wheels (15 and 16) on each planet gear shaft (14).

**Note:** The two planet wheels are different: on gear wheel I (15), teeth of upper and lower gearing are aligned, while they are displaced ½ tooth on gear wheel II (16).

**Step 2**

Mount planet gear bushing (17) in top of planet gear frame (13) – eg. use impeller shaft (18) to apply pressure to the planet gear bushing (17).

### Turbine assembly (if it has been disassembled)

**Step 3**

Insert an O-ring (20) on either side of the impeller (19).

**Step 4**

Mount the impeller with O-rings onto the impeller shaft (18).

**Step 5**

It is recommended to slightly grease the thread with food grade/FDA compliant grease. The grease reduces the risk of galling in threads. The grease is enclosed between O-rings and, therefore, it will not come into contact with the cleaning media.

**Step 6**

Screw the shaft end (21) into the impeller shaft (18). Tighten to metal-to-metal stop (10-12 Nm). Use tool TE20J591 to fixate the impeller shaft (18).

### Guide assembly (if it has been disassembled)

**Step 7**

Insert bearing for turbine shaft top (26) into the guide (25) and press it in.

### Nozzle assembly (if it has been disassembled)

**Step 8**

Mount O-ring (29) into O-ring groove just after the threads on the nozzle (27).

## 6 Maintenance

---

TJ40G

---

### Ball race (if replaced during maintenance)

#### Step 9

Mount ball race (4) on hub (3) using support ring – press together in bench vise.

---

#### Step 10

Mount ball race (4) on stem (11) using support ring – press together in bench vise.

---

### Gear ring assembly (if it has been disassembled)

#### Step 11

Mount seal ring (8) in gear ring (7).

---

#### Step 12

Mount bearing for body (9) on the gear ring (7). Use pin punch between bearing for body (9) and rubber hammer to apply pressure. NB: Ensure bottom of bearing for body (9) is flush with the bottom of the gear ring (7) after insertion.

---

### Machine assembly

#### Step 13

Put ball retainer w. balls (5) around hub (3).

---

#### Step 14

Mount O-ring (2) over body (1).

---

#### Step 15

Put hub nut (6) around hub (3).

---

#### Step 16

Mount the hub (3) (with ball retainer and hub nut) into the hub part of the body (1). After screwing in the hub nut (6) almost all the way (left hand thread), move the O-ring (2) from around the body (1) into the O-ring groove on the body (1). Tighten the hub nut (6) to the body (1). NB: make sure O-ring (2) is in the O-ring groove. **NB:** Wet the surface of the O-ring (2) with water to ease the assembly. Tighten to metal-to-metal stop. **IMPORTANT:** No lubricants and lock tight to be used.



#### Step 17

Mount the hub (3) in bench vise and turn the body (1) so the stem part of the body (1) is upwards.



#### Step 18

Insert gear ring (7) into body (1) and fasten it using the 3 screws for body (10) with a torque of 4.5-5 Nm. **NB:** It may be necessary to rotate the gear ring (7) so the holes fits with the thread holes in the body (1).

---

#### Step 19

Insert stem (11) into the body (1).

---

#### Step 20

Place ball retainer w. balls (5) around stem (11).

---

#### Step 21

Place stem nut (12) around the stem (11) and tighten the stem nut (12) into the body (1) (right hand thread). **IMPORTANT:** No lubricants and lock tight to be used. (It may be necessary to lift the stem (11) a little while turning the stem nut (12).

---



TJ40G

---

### Step 22

Place O-ring (23) around the stem (11).

---

### Step 23

Insert planet gear assembly into stem (11) and into the gear ring (7). NB: it may be necessary to wiggle the machine a little to get the planet gear assembly to fall in place.

---

### Step 24

Insert O-ring (22) into the O-ring groove on top of the stem (11).

---

### Step 25

Insert impeller assembly into the planet gear assembly – rotate the impeller (19) by hand to ensure that it rotates freely. (By hand support the body (1) of the machine to aid the rotation).

---

### Step 26

Mount guide (25) onto top of stem (11) (and the O-ring).

---

### Step 27

Insert O-ring (22) into the O-ring groove on top of the guide (25) (right hand thread).

---

### Step 28

It is recommended to slightly grease the thread with food grade/FDA compliant grease. The grease reduces the risk of galling in threads. The grease is enclosed between O-rings and, therefore, it will not come into contact with the cleaning media.

---

### Step 29

Mount the cone (24) over the guide assembly and catch the thread on the stem (11) and tighten the cone (24) on to the stem (11). NB: make sure O-rings are in the O-ring grooves. **NB:** Wet the surface of the O-rings with water to ease the assembly. Tighten to metal-to-metal stop.



---

### Step 30

Insert gasket (30) into top part of cone (24).

---

### Step 31

Remove the assembly from the bench vise.

---

### Step 32

Mount nozzle w. gaskets (27) into the hub (3). **NB:** Make sure O-rings are in the O-ring grooves. E.g. use a finger to push O-ring in guide back in place while fastening the cone. **NB:** Wet the surface of the O-rings with water to ease the assembly. Tighten to metal-to-metal stop – torque of 70 Nm. **IMPORTANT:** No lubricants and lock tight to be used.



After reassembly check if the turbine rotates freely using an 8 mm socket wrench at the top of the turbine and turn it anticlockwise, while holding the machine by the cone. The hub with nozzles should rotate very slowly.

---

## 7 Trouble shooting guide

TJ40G

Symptom: Slow rotation or failure of the machine to rotate:

Possible Causes	Fault finding
<b>No or insufficient liquid flow</b>	<p>a). Check if supply valve is fully open.</p> <p>b). Check if inlet pressure to machine is correct.</p> <p>c). Check supply line/filter for restrictions/clogging.</p> <p>d). Remove nozzles and check for clogging. If blocked, carefully clean nozzle without damaging nozzles vanes and nozzle tip.</p> <p>e). Remove cone (see page 21) and check for clogging in guide and impeller area.</p> <p>If large particles repeatedly get jammed in the machine, install filter or reduce mesh size of installed filter (1 mm) in supply line or contact Alfa Laval for other solutions.</p>
<b>Foreign material or material build-up</b>	<p>Insert socket wrench on top of turbine shaft and easily turn turbine shaft anticlockwise. If any resistance is recognised, disassemble machine to localise cause.</p>
a). Impeller jammed	Remove turbine shaft assembly and planet gear assembly (see page 21) and remove foreign material.
b). Turbine shaft sluggish in bearing	Remove turbine shaft assembly (see page 21) and clean bearing.
c). Planet gear jammed/sluggish	Remove foreign material from planet wheels and internal gears. Check rotation of planet wheels. If restriction is recognised, disassemble planet gear assembly (see page 21) and remove material build up, especially on shafts and bushes in planet wheels.
d). Stem or hub jammed/sluggish	Remove planet gear assembly (see page 21). Turn hub and check unrestricted rotation. Remove stem and hub (see page 21 ff). Remove foreign material/material build-up on stem, hub and inside nut. Clean Ball races and ball retainer with balls. Assemble stem/hub, ball retainer with balls and stem/hub nut.
e). Bevel gears jammed	Remove stem and hub (see page 21 ff). Clean teeth on stem and hub.
<b>Wear</b>	
a). Slide bearings	See page 19.
b). Bearings for turbine shaft	See page 19.
c). Planet wheels	See page 19.
d). Shafts for planet wheels	Check clearance of planet wheels on shafts. Transverse movement should not exceed 0.3 mm.
e). Turbine shaft	Check clearance in planet gear bearing and bearing for turbine shaft. Transverse movement should not exceed 0.3 mm. Also inspect teeth for wear.
<b>Mechanical defects</b>	
a). Planet wheels. Teeth broken	Replace planet wheel.
b). Planet wheel can not rotate on shafts/shafts bent	Replace planet gear frame.
c). Damaged teeth on bevel gear	Inspect teeth on stem and hub for deformation. Mount hub and stem in body (See page 23). Hold body in upside down position and rotate hub to check that bevel gears can work together. If damaged: Replace stem and/or hub.
d). Damage on stem and hub-nut	If hard particles get stuck between stem nut and stem or hub nut and hub, the particles will damage the parts. The damaged parts should be replaced.

TJ40G

Weight of machine:	6.3 kg (13.9 lb)
	6.7 kg (14.8 lb) including welding adapter
Recommended inlet pressure:	5-7 bar (70-100 psi)
Max. inlet pressure:	12 bar (174 psi)
Max. recommended working liquid temperature	95°C (200°F)
Max. recommended working steam temperature	140°C (284°F)
Ambient temperature:	140°C (284°F) when not operated
Materials:	Stainless Steel AISI 316, SAF 2205, PFA HP, PEEK, EPDM
Max. permitted process fluid pressure:	12 bar.

### Principal dimensions in mm

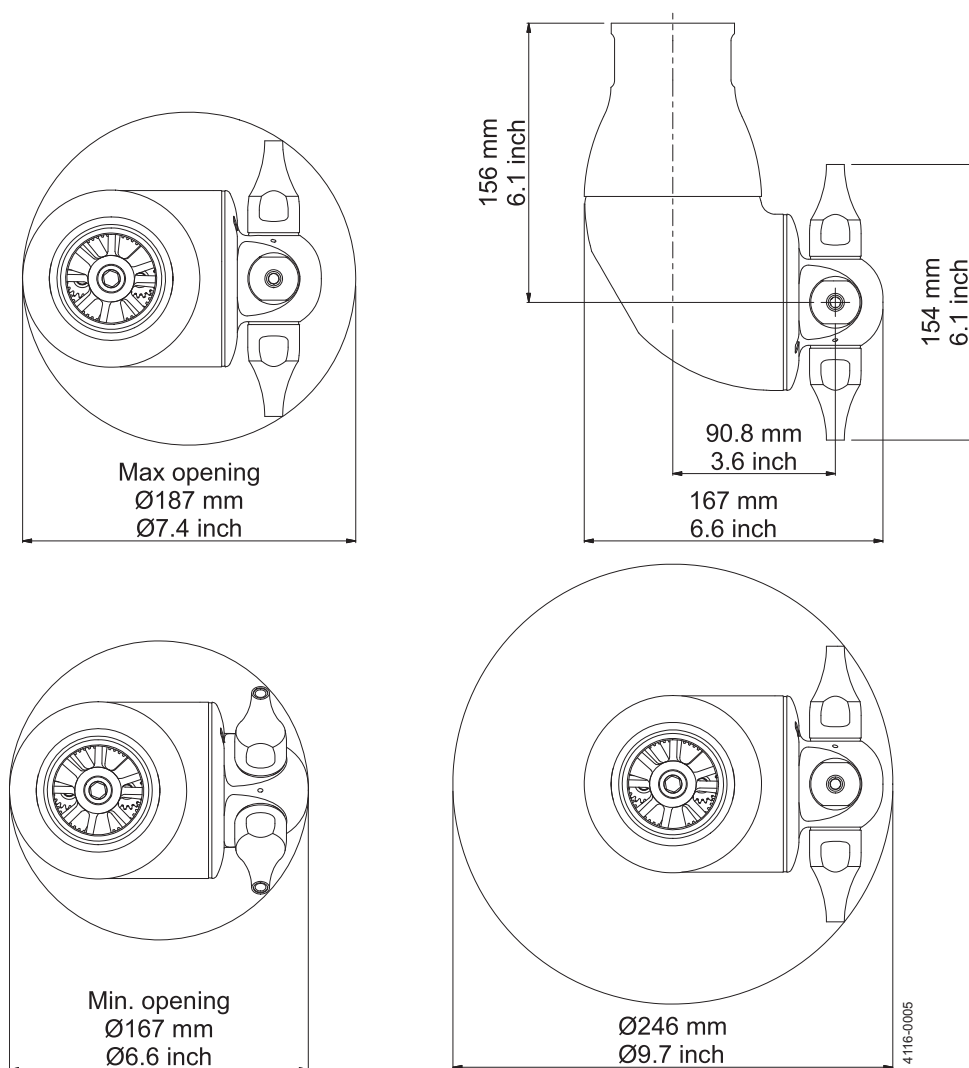

Minimum required passage: Tilted ~30°: ø167 mm (6.6 inch). Otherwise ø187 mm (7.4 inch).

## 8 Technical data

TJ40G

### 8.1 Performance data for TJ40G

Article numbers 96900003XX (TJ40G)

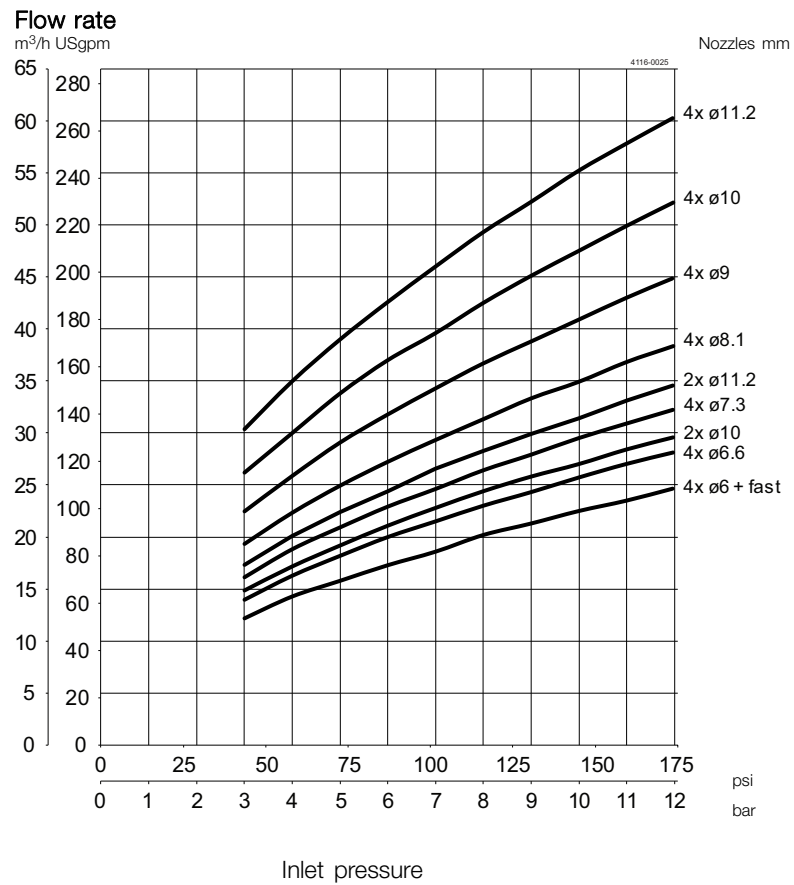

Article numbers 96900004XX (TJ40G Burst)

Burst machines: + 5 m<sup>3</sup>/h

TJ40G

Article numbers 96900003XX (TJ40G)

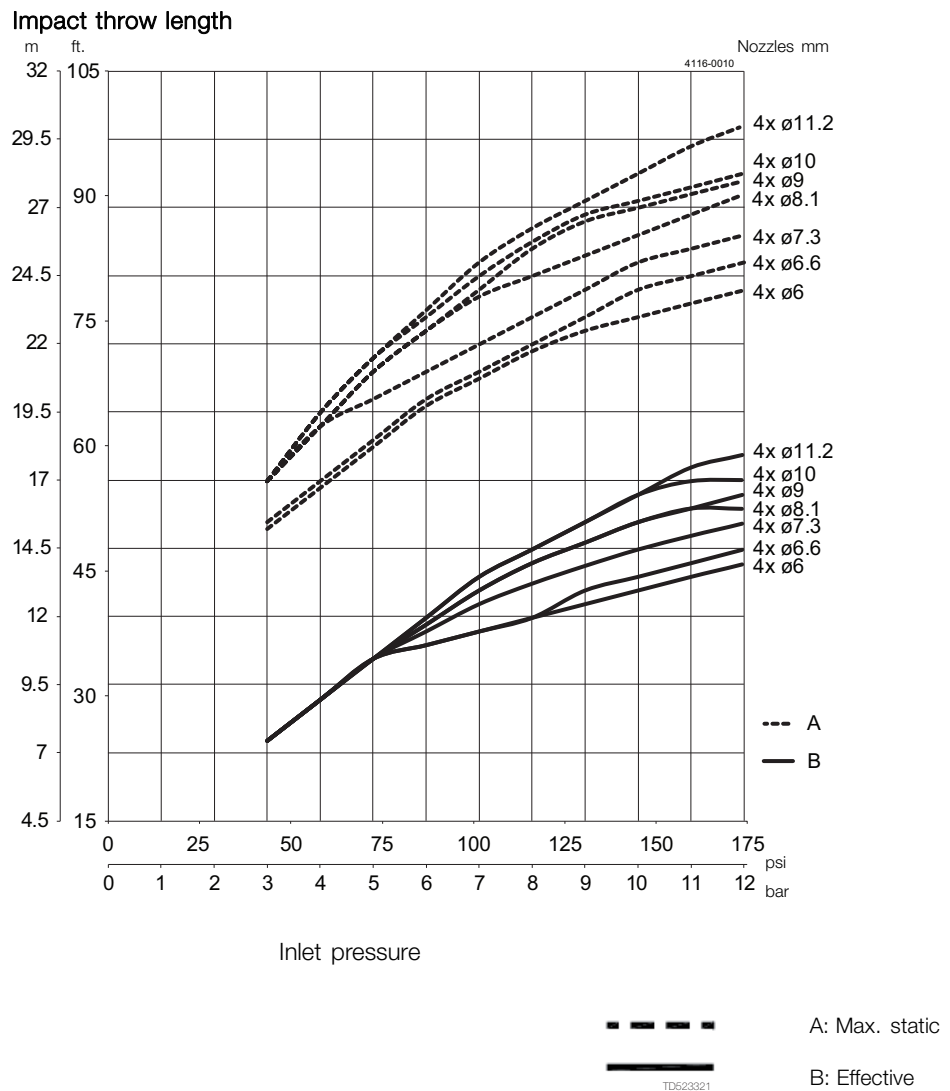

**Note:** Throw lengths are measured as horizontal throw length at static condition. Vertical throw length upwards is approx. 1/3 less. Throw lengths are defined and measured as given in Alfa Laval Technical Specification 93P003. Effective throw length varies depending on jet transverse speed over surface, substance to be removed, cleaning procedure and agent. The inlet pressure has been taken immediately before the machine inlet. In order to achieve the performance indicated in the curves, the pressure drop in the supply lines between pump and machine must be taken into consideration.

# 8 Technical data

TJ40G

Article numbers 96900003XX (TJ40G)

Cleaning time for complete pattern (= 8 cycles)

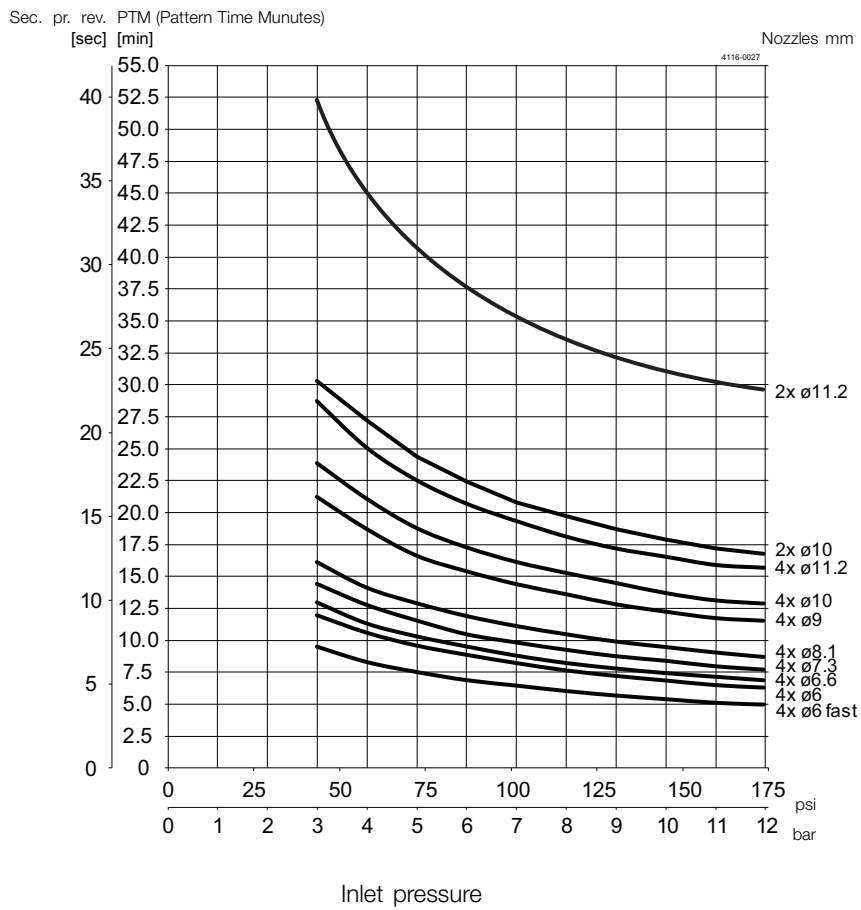

TJ40G

8.2 Performance data for TJ40G-HD

Article numbers 96900002XX (TJ40G-HD)

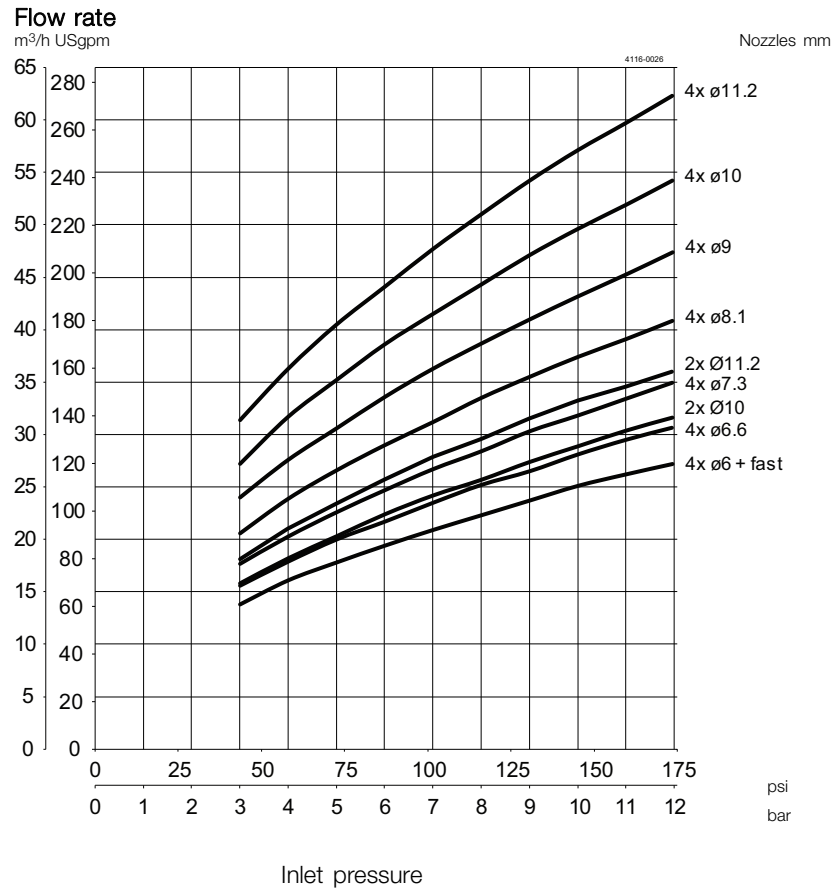

Article numbers 96900001XX (TJ40G-HD Burst)  
 Burst machines: + 5 m³/h

# 8 Technical data

TJ40G

Article numbers 96900002XX (TJ40G-HD)

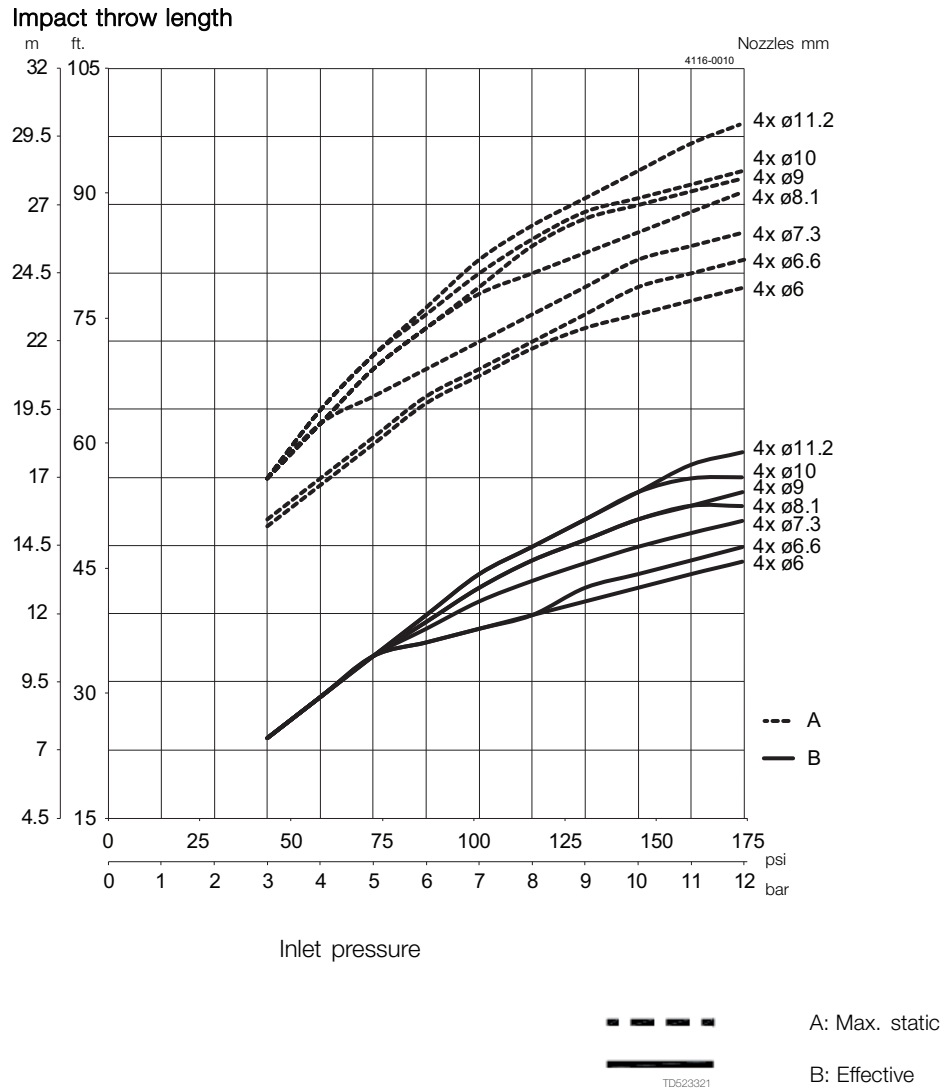

**Note:** Throw lengths are measured as horizontal throw length at static condition. Vertical throw length upwards is approx. 1/3 less. Throw lengths are defined and measured as given in Alfa Laval Technical Specification 93P003. Effective throw length varies depending on jet transverse speed over surface, substance to be removed, cleaning procedure and agent. The inlet pressure has been taken immediately before the machine inlet. In order to achieve the performance indicated in the curves, the pressure drop in the supply lines between pump and machine must be taken into consideration.



TJ40G

Article numbers 96900002XX (TJ40G-HD)

Cleaning time for complete pattern (= 8 cycles)

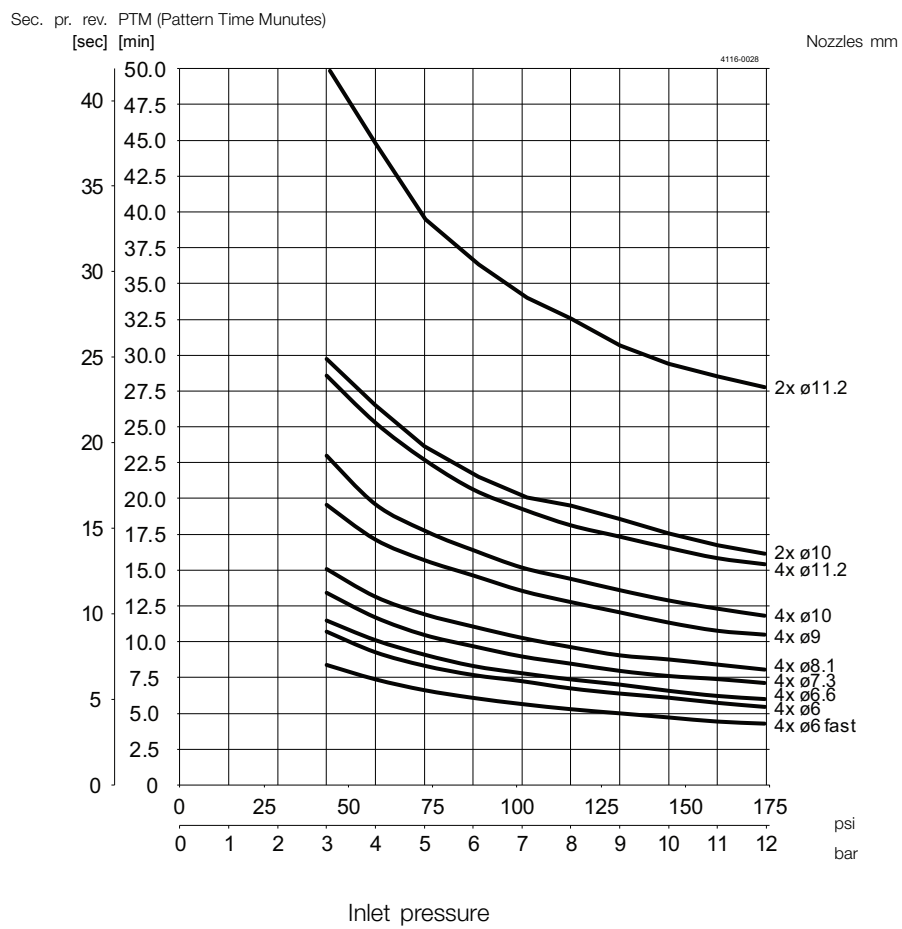

## 9 Product programme

This manual covers the product program for Alfa Laval Tofteborg TJ40G tank cleaning machine

### 9.1 Standard Configurations

Configuration	Standard					Heavy Duty (HD)					Documentation	
	Item number					Item number					Q-Doc	ATEX/IECEX
4 x Ø6, fast	9690	-	0003	-	01	9690	-	0002	-	01		
4 x Ø6	9690	-	0003	-	02	9690	-	0002	-	02		
4 x Ø6.6	9690	-	0003	-	03	9690	-	0002	-	03		
4 x Ø7.3	9690	-	0003	-	04	9690	-	0002	-	04		
4 x Ø8.1	9690	-	0003	-	05	9690	-	0002	-	05		
4 x Ø9	9690	-	0003	-	06	9690	-	0002	-	06		
4 x Ø10	9690	-	0003	-	07	9690	-	0002	-	07		
4 x Ø11.2	9690	-	0003	-	08	9690	-	0002	-	08		
4 x Ø6, fast	9690	-	0003	-	09	9690	-	0002	-	09	x	
4 x Ø6	9690	-	0003	-	10	9690	-	0002	-	10	x	
4 x Ø6.6	9690	-	0003	-	11	9690	-	0002	-	11	x	
4 x Ø7.3	9690	-	0003	-	12	9690	-	0002	-	12	x	
4 x Ø8.1	9690	-	0003	-	13	9690	-	0002	-	13	x	
4 x Ø9	9690	-	0003	-	14	9690	-	0002	-	14	x	
4 x Ø10	9690	-	0003	-	15	9690	-	0002	-	15	x	
4 x Ø11.2	9690	-	0003	-	16	9690	-	0002	-	16	x	
4 x Ø6, fast	9690	-	0003	-	17	9690	-	0002	-	17		x
4 x Ø6	9690	-	0003	-	18	9690	-	0002	-	18		x
4 x Ø6.6	9690	-	0003	-	19	9690	-	0002	-	19		x
4 x Ø7.3	9690	-	0003	-	20	9690	-	0002	-	20		x
4 x Ø8.1	9690	-	0003	-	21	9690	-	0002	-	21		x
4 x Ø9	9690	-	0003	-	22	9690	-	0002	-	22		x
4 x Ø10	9690	-	0003	-	23	9690	-	0002	-	23		x
4 x Ø11.2	9690	-	0003	-	24	9690	-	0002	-	24		x
4 x Ø6, fast	9690	-	0003	-	25	9690	-	0002	-	25	x	x
4 x Ø6	9690	-	0003	-	26	9690	-	0002	-	26	x	x
4 x Ø6.6	9690	-	0003	-	27	9690	-	0002	-	27	x	x
4 x Ø7.3	9690	-	0003	-	28	9690	-	0002	-	28	x	x
4 x Ø8.1	9690	-	0003	-	29	9690	-	0002	-	29	x	x
4 x Ø9	9690	-	0003	-	30	9690	-	0002	-	30	x	x
4 x Ø10	9690	-	0003	-	31	9690	-	0002	-	31	x	x
4 x Ø11.2	9690	-	0003	-	32	9690	-	0002	-	32	x	x
2 x Ø10	9690	-	0003	-	39	9690	-	0002	-	39		
2 x Ø10	9690	-	0003	-	47	9690	-	0002	-	47	x	
2 x Ø10	9690	-	0003	-	55	9690	-	0002	-	55		x
2 x Ø10	9690	-	0003	-	63	9690	-	0002	-	63	x	x
2 x Ø11.2	9690	-	0003	-	40	9690	-	0002	-	40		
2 x Ø11.2	9690	-	0003	-	48	9690	-	0002	-	48	x	
2 x Ø11.2	9690	-	0003	-	56	9690	-	0002	-	46		x
2 x Ø11.2	9690	-	0003	-	64	9690	-	0002	-	64	x	x

## 9 Product programme

This manual covers the product program for Alfa Laval Toftejorg TJ40G tank cleaning machine



### 9.2 Standard Configurations, Burst

Configuration	Standard, Burst					Heavy Duty (HD), Burst					Documentation	
	Item number					Item number					Q-Doc	ATEX/IECEX
4 x Ø6, fast	9690	-	0001	-	01	9690	-	0004	-	01		
4 x Ø6	9690	-	0001	-	02	9690	-	0004	-	02		
4 x Ø6.6	9690	-	0001	-	03	9690	-	0004	-	03		
4 x Ø7.3	9690	-	0001	-	04	9690	-	0004	-	04		
4 x Ø8.1	9690	-	0001	-	05	9690	-	0004	-	05		
4 x Ø9	9690	-	0001	-	06	9690	-	0004	-	06		
4 x Ø10	9690	-	0001	-	07	9690	-	0004	-	07		
4 x Ø11.2	9690	-	0001	-	08	9690	-	0004	-	08		
4 x Ø6, fast	9690	-	0001	-	09	9690	-	0004	-	09	x	
4 x Ø6	9690	-	0001	-	10	9690	-	0004	-	10	x	
4 x Ø6.6	9690	-	0001	-	11	9690	-	0004	-	11	x	
4 x Ø7.3	9690	-	0001	-	12	9690	-	0004	-	12	x	
4 x Ø8.1	9690	-	0001	-	13	9690	-	0004	-	13	x	
4 x Ø9	9690	-	0001	-	14	9690	-	0004	-	14	x	
4 x Ø10	9690	-	0001	-	15	9690	-	0004	-	15	x	
4 x Ø11.2	9690	-	0001	-	16	9690	-	0004	-	16	x	
4 x Ø6, fast	9690	-	0001	-	17	9690	-	0004	-	17		x
4 x Ø6	9690	-	0001	-	18	9690	-	0004	-	18		x
4 x Ø6.6	9690	-	0001	-	19	9690	-	0004	-	19		x
4 x Ø7.3	9690	-	0001	-	20	9690	-	0004	-	20		x
4 x Ø8.1	9690	-	0001	-	21	9690	-	0004	-	21		x
4 x Ø9	9690	-	0001	-	22	9690	-	0004	-	22		x
4 x Ø10	9690	-	0001	-	23	9690	-	0004	-	23		x
4 x Ø11.2	9690	-	0001	-	24	9690	-	0004	-	24		x
4 x Ø6, fast	9690	-	0001	-	25	9690	-	0004	-	25	x	x
4 x Ø6	9690	-	0001	-	26	9690	-	0004	-	26	x	x
4 x Ø6.6	9690	-	0001	-	27	9690	-	0004	-	27	x	x
4 x Ø7.3	9690	-	0001	-	28	9690	-	0004	-	28	x	x
4 x Ø8.1	9690	-	0001	-	29	9690	-	0004	-	29	x	x
4 x Ø9	9690	-	0001	-	30	9690	-	0004	-	30	x	x
4 x Ø10	9690	-	0001	-	31	9690	-	0004	-	31	x	x
4 x Ø11.2	9690	-	0001	-	32	9690	-	0004	-	32	x	x
2 x Ø10	9690	-	0001	-	39	9690	-	0004	-	39		
2 x Ø10	9690	-	0001	-	47	9690	-	0004	-	47	x	
2 x Ø10	9690	-	0001	-	55	9690	-	0004	-	55		x
2 x Ø10	9690	-	0001	-	63	9690	-	0004	-	63	x	x
2 x Ø11.2	9690	-	0001	-	40	9690	-	0004	-	40		
2 x Ø11.2	9690	-	0001	-	48	9690	-	0004	-	48	x	
2 x Ø11.2	9690	-	0001	-	56	9690	-	0004	-	46		x
2 x Ø11.2	9690	-	0001	-	64	9690	-	0004	-	64	x	x

## 9 Product programme

This manual covers the product program for Alfa Laval Toftejorg TJ40G tank cleaning machine

### 9.3 Available Add-ons

Explanation to Add-ons		
<p><b>Q-doc</b> (Equipment Documentation)</p>		<p>Equipment Documentation includes:</p> <ul style="list-style-type: none"> <li>- EN 1935/2004 DoC</li> <li>- EN 10204 type 3.1 inspection Certificate and DoC</li> <li>- FDA DoC</li> <li>- GMP EC 2023/2006 DoC</li> <li>- EU 10/2011 DoC</li> <li>- ADI DoC</li> <li>- QC DoC</li> </ul>
<p><b>ATEX/IECEx</b></p>		<p>ATEX/IECEx includes: ATEX/IECEx certified machine for use in explosive atmospheres. Category 1 for installation in zone 0/20 in accordance with directive 2014/34/EU.</p> <p>II 1G Ex h IIC 85°C...175°C    Ga II 1D Ex h IIC T85°C...T140°C    Da</p>

### 9.4 Available add-ons for spare parts

Item no.	Description
<p><b>Q-doc</b> 9690003102 or 9690006202 or 9690006502</p>	<p>Q-doc including</p> <ul style="list-style-type: none"> <li>- EN 1935/2004 DoC</li> <li>- EN 10204 type 3.1 inspection Certificate and DoC</li> <li>- FDA DoC</li> <li>- GMP EC 2023/2006 DoC</li> <li>- EU 10/2011 DoC</li> <li>- ADI DoC</li> <li>- QC DoC</li> </ul>

This manual covers the product program for Alfa Laval Toftejorg TJ40G tank cleaning machine

### 9.5 Available welding and thread adaptors

Welding adapter (see right) with sealing assembly between down pipe, welding adapter and machine. Welding connections are ordered separately. For use with sanitary connection cones use cone with seal (seals are included for machines with sanitary cone).

Item no.:	Down pipe**
9690006601	2"ISO pipe
9690006602	DN65R2
9690006603	2½"Dairy pipe
9690006604	2"NPT (male)
9690006605	DN50R2
9690006606	DN40R1
9690006607	2"Dairy pipe
9690006608	1½"ISO pipe
9690006609	1½"NPT (male)
9690006610	1½"ISO (male)
9690006611	1½" ISO (female)
9690006612	2" ISO (female)
9690006613	1½" NPT (female)
9690006614	2" NPT (female)

\* Includes gaskets for sanitary installation

\*\* Either Dimension or existing thread on pipe

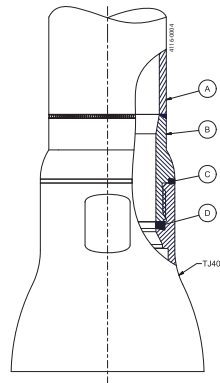









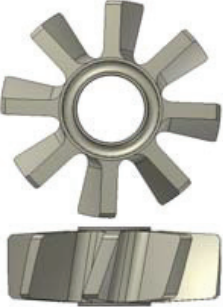

A: Down pipe  
 B: Welding adapter  
 C: Seal PTFE  
 D: Seal EPDM

## 9 Product programme

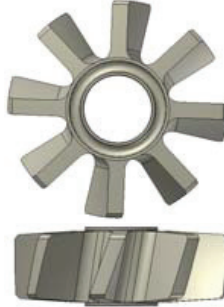
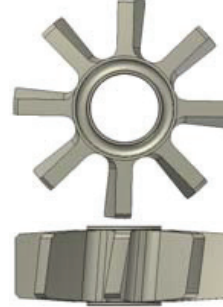
This manual covers the product program for Alfa Laval Toftejorg TJ40G tank cleaning machine

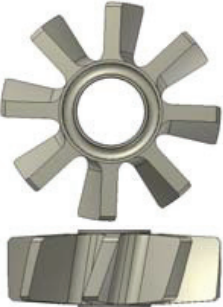
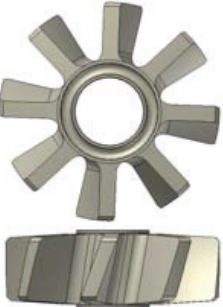
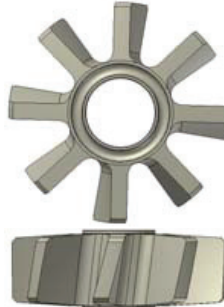
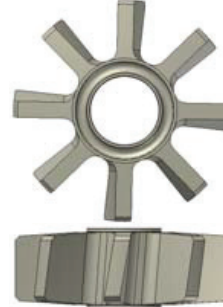

### 9.6 Overview of guide and turbine combinations - 4 nozzles

Nozzle size	4x Ø6, fast	4x Ø6	4x Ø6.6	4x Ø7.3
Guide				
	9690-0044-01 9690-0050-01	9690-0043-01 9690-0049-01	9690-0043-01 9690-0049-01	9690-0043-01 9690-0049-01
Turbine				
	9690-0028-01	9690-0030-01	9690-0028-01	9690-0026-01
Nozzle size	4x Ø8.1	4x Ø9	4x Ø10	4x Ø11.2
Guide				
	9690-0041-01 9690-0047-01	9690-0039-01 9690-0045-01	9690-0039-01 9690-0045-01	9690-0039-01 9690-0045-01
Turbine				
	9690-0028-01	9690-0028-01	9690-0027-01	9690-0026-01

4116-0012

This manual covers the product program for Alfa Laval Toftejorg TJ40G tank cleaning machine

### 9.7 Overview of guide and turbine combinations - 2 nozzles

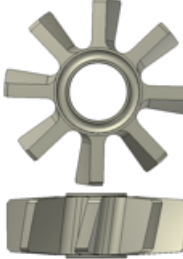
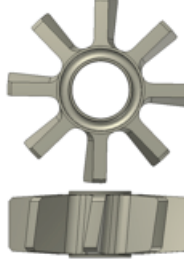
Nozzle size	2x $\varnothing 10$	2x $\varnothing 11.2$
<b>Guide</b>	 9690-0040-01 9690-0046-01	 9690-0039-01 9690-0045-01
<b>Turbine</b>	 9690-0027-01	 9690-0026-01

4116-0024

# 10 Parts drawings, parts lists, service kits and tools

TJ40G

## 10.1 Alfa Laval Toftejorg TJ40G

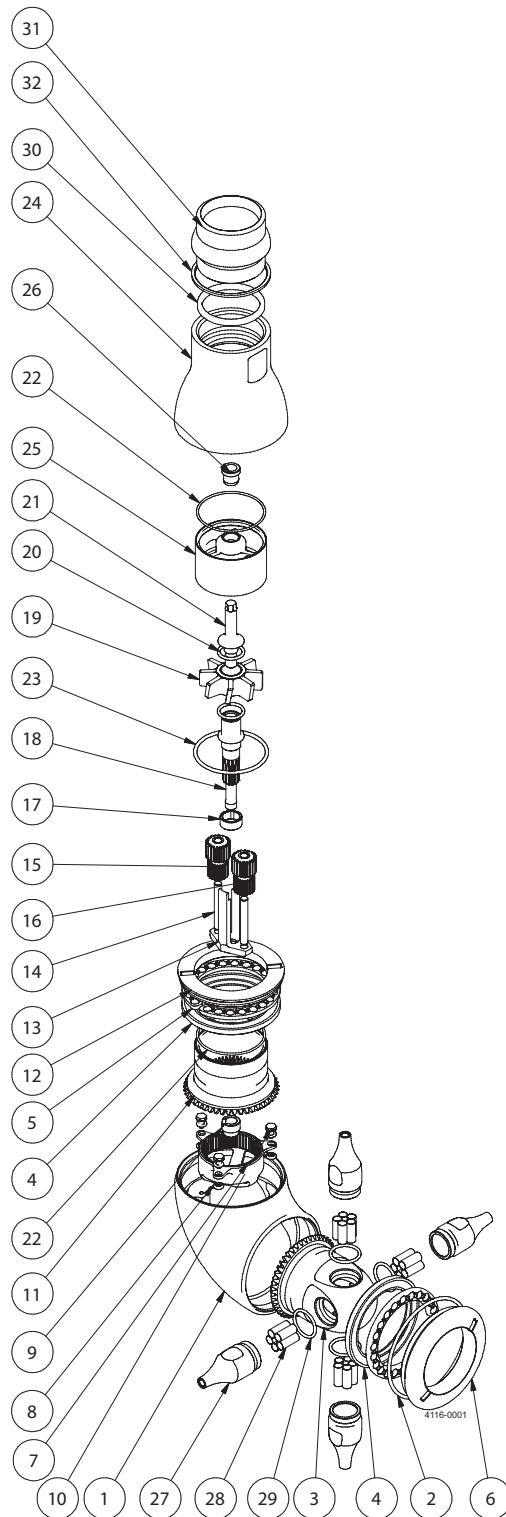



# 10 Parts drawings, parts lists, service kits and tools

TJ40G

## Parts list

Pos.	Qty	Denomination
1	1	Body
2	1	O-ring
3	1	Hub
4	2	Ball race
5	2	Ball retainer w. balls
6	1	Hub nut
7	1	Gear ring
8	6	Seal ring
9	1	Bearing f. body
10	3	Screw f. body
11	1	Stem
12	1	Stem nut
13	1	Gear frame
14	2	Shaft f. planet gear
15	1	Gear wheel I
16	1	Gear wheel II
17	1	Bushing f. planet gear
18	1	Impeller shaft
19	1	Impeller
20	2	O-ring
21	1	Shaft end
22	2	O-ring
23	1	O-ring
24	1	Cone
25	1	Guide
26	1	Bearing f. turbine top
27.1	4/2	Nozzle
	4/2	Nozzle, Burst
27.2	0/2	Blind cap
28	20/10	Nozzle vane
29	4	O-ring
30	1	Gasket f. cone - inside

## Service kits

Denomination	
<b>Service kits</b>	
Minor service kit TJ40G.....	9690003101
Minor service kit TJ40G - Q-Doc .....	9690003102
Major service kit TJ40G.....	9690006201
Major service kit TJ40G-HD - Q-Doc.....	9690006202

Configuration according to delivery note/order.

Parts marked with ✦ are included in the Minor Service Kit for TJ40G: 96900031XX

Parts marked with ● are included in the Major Service Kit for TJ40G: 96900062XX

See page 36 for more information on available add-ons.

# 10 Parts drawings, parts lists, service kits and tools

TJ40G-HD

## 10.2 Alfa Laval Toftejorg TJ40G-HD

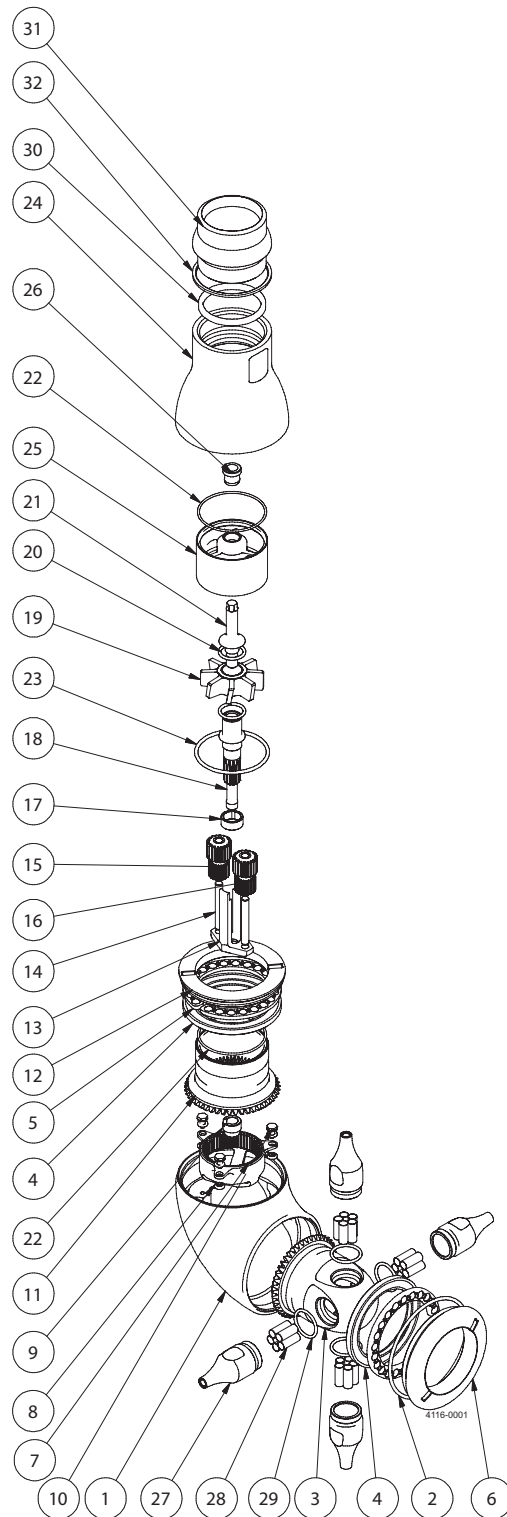

## 10 Parts drawings, parts lists, service kits and tools

TJ40G-HD

### Parts list

Pos.	Qty	Denomination
1	1	Body
2	1	◇● O-ring
3	1	Hub
4	2	● Ball race
5	2	● Ball retainer w. balls
6	1	● Hub nut - HD
7	1	Gear ring
8	6	Seal ring
9	1	◇● Bearing f. body
10	3	Screw f. body
11	1	Stem
12	1	● Stem nut - HD
13	1	Gear frame
14	2	Shaft f. planet gear
15	1	◇● Gear wheel I
16	1	◇● Gear wheel II
17	1	◇● Bushing f. planet gear
18	1	Impeller shaft
19	1	□ Impeller
20	2	O-ring
21	1	Shaft end
22	2	◇● O-ring
23	1	◇● O-ring
24	1	Cone
25	1	□ Guide
26	1	◇● Bearing f. turbine top
27.1	4/2	□ Nozzle
	4/2	□ Nozzle, Burst
27.2	0/2	□ Blind cap
28	20/10	Nozzle vane
29	4	◇● O-ring
30	1	Gasket f. cone - inside

### Service kits

Denomination	
<b>Service kits</b>	
Minor service kit TJ40G-HD .....	9690003101
Minor service kit TJ40G-HD - Q-Doc.....	9690003102
Major service kit TJ40G-HD .....	9690006501
Major service kit TJ40G-HD - Q-Doc.....	9690006502

Configuration according to delivery note/order.

Parts marked with ◇ are included in the Minor Service Kit for TJ40G-HD: 96900031XX

Parts marked with ● are included in the Major Service Kit for TJ40G-HD: 96900065XX

See page 36 for more information on available add-ons.

## 10 Parts drawings, parts lists, service kits and tools

TJ40G

### 10.3 Tools

#### Alfa Laval Toftejorg TJ40G Tool kit Article number TE81B149

Denomination	Qty x tool item number
Fixture f. Impeller	1 x TE20J591
5 mm calipers	1 x TE369
Ring fork key NV24	1 x TE81B140
NV8 socket long	1 x TE81B157
Torque wrench 1/4" 5 - 25 Nm	1 x TE81B156
Pin punch ø8	1 x TE81B148
Ring fork key NV65	1 x TE81B147

#### Other tools f. TJ40G

Denomination	Item number
Ball race tool f. TJ40G	9690007801
Nut tool	9690007901
Socket f. TJ40G nozzles	9690008001

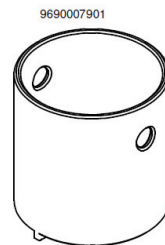
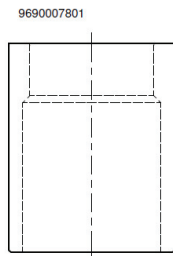

TJ40G

---

### 11.1 Service and repair

---

Upon every return of a product, no matter if for modifications or repair, it is necessary to contact your local Alfa Laval office to guarantee a quick execution of your request.

You will receive instructions regarding the return procedure from your local Alfa Laval office. Be sure to follow the instructions closely.

---

### 11.2 How to order spare parts

---

On the parts drawings as well as on all instruction drawings, the individual parts have a position number, which is the same on all drawings. From the position number, the part is easily identified in the parts lists, page 40 ff.

Individual parts should always be ordered from the parts lists, page 40 ff. Item number and denomination should be clearly stated. Please refer to the Spare Part Manual for information on item numbers. The Spare Part manual is available from the on-line Alfa Laval product catalogue Anytime or the Close at hand spare part catalogue.

Please also quote the type of machine and serial number. This will help us to help you. The type and serial numbers are stamped on the body of the tank cleaning machine.

In cases where spare parts are ordered for machines originally delivered with 3.1 certificates, please state this information on your ordering form together with the machine type and serial number. This is to ensure full traceability henceforward.

### 11.3 How to contact Alfa Laval Kolding A/S

---

For further information please feel free to contact:

**Alfa Laval Kolding A/S**

31, Albuen - DK 6000 Kolding - Denmark

Registration number: 30938011

Tel switchboard: +45 79 32 22 00 - Fax switchboard: +45 79 32 25 80

www.toftejorg.com, www.alfalaval.dk - info.dk@alfalaval.com

Contact details for all countries are continually updated on our websites

---

## 12 Miscellaneous

TJ40G

### 12.1 Declaration of Conformity, EN 10474, sub clause 2.2 Test Report



**Declaration Of Conformity  
with  
EN 10204, Sub Clause 2.2 Test Report  
Materials of Construction and Surface Finishes**

Alfa Laval Kolding A/S (supplier)

declare, under our sole responsibility, that the following product:

Description
Alfa Laval Toftejord TJ40G Rotary Jet Head

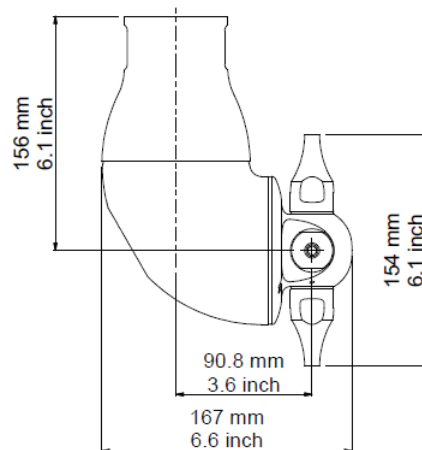

has been subjected to non-specific controls for product quality and are found to conform with the following standards and other normative documents:

#### Metal Materials

AISI 316	Werkstoff No. 1.4401
AISI 316L	Werkstoff No. 1.4404
SAF 2205	Werkstoff No. 1.4462

1 of 2

This certificate is delivered in compliance with the latest valid design and construction. Alfa Laval Kolding A/S reserve the right to alter or modify any unit specification without notice or any obligation.  
Rev. 2. 20170901

**Non-Metal Materials**

21CFR§177.1550 (PTFE)

21CFR§177.2600 (EPDM)

21CFR§177.2415 (PEEK)

**Surface Finish**

All parts are finished with a nominal external roughness Ra = 0.8 µm (30 micro inch).

**Non-Specific Controls on Product Quality "As-Supplied"**

All metallic part material certifications are inspected upon receipt before assembly.

Parts inspections are completed according to the approved ISO 9001:2008 standard program. The Quality Control Department only accepts the product in component parts for assembly according to this program if the parts comply with the above material specification documentation.

Product welds are executed, inspected and finished (polished where accessible), according to written, approved procedures.

Parts produced from FDA approved polymers are only sourced from suppliers that have met "pre-qualification" standards established by Alfa Laval Kolding's ISO 9001:2008 program. Materials of construction of component parts are controlled through clear and explicit specifications in purchase orders. These specifications include the materials of construction specified by the parts designers, making them subject to the contractual terms and conditions.

The following item numbers are covered by this certificate:

96900001xx
96900002xx
96900003xx
96900004xx

Copenhagen, Ishoej, on September 1, 2017  
For Alfa Laval Kolding A/S



Annie Dahl  
QHSE Manager

2 of 2

This certificate is delivered in compliance with the latest valid design and construction. Alfa Laval Kolding A/S reserve the right to alter or modify any unit specification without notice or any obligation.  
Rev. 2. 20170901

## 12 Miscellaneous

TJ40G

### 12.2 Declaration of Compliance with 10/2011 – Food contact materials

#### Declaration of compliance for food contact materials



Article Nr: 9690-0001-xx  
9690-0002-xx  
9690-0003-xx  
9690-0004-xx

Product TJ40G

We, Alfa Laval Kolding A/S, hereby certify that the plastic articles intended to come into contact with product included in the article stated above comply with the Regulation (EC) No. 1935/2004 and the Regulation (EC) No. 10/2011 both in their relevant versions on materials and articles intended to come in contact with food.

Finished articles subject to an overall migration limit of 10 mg/dm<sup>2</sup> or 60 mg/kg. The following substances subject to limitations are used in the above stated article: SML:

	PEEK 450G	TECAPEEK TF10
Diphenylsulphor	3 mg/kg food	-
1,4 Dihydroxybenzol	0.6 mg/kg food	0.6 mg/kg food
4,4' Defluorobenzopheneone	0.05 mg/kg food	0.05 mg/kg food
TFE	-	0.05 mg/kg food
Substance 3*	-	3 mg/kg food
Substance 4*	-	0.05 mg/kg food

\*) This information is provided only under a non-disclosure agreement for the purpose of conformance testing.

	PFA
TFE	0.05 mg/kg food
PPVE	0.05 mg/kg food

Migration from the plastic articles has been investigated by calculations as laid down in paragraph (32) in Regulation (EC) No. 10/2011, to control that the migration limits and other requirements are fulfilled. The articles can be used, within its application area, with all type of foods at batch size above 1,500 kg\*.

We also certify that the plastic articles intended to come into contact with product included in the article stated above are also entirely in accordance with the present US regulation FDA CFR 21§ 177.

Soborg, 08-11-2016

Henrik Falster-Hansen,  
R&D Manager  
Alfa Laval Kolding A/S

\*Based on worst case scenario = all of the free monomer in the plastic migrates to one batch.

Alfa Laval Kolding A/S  
Albuen 31, DK-6000 Kolding  
Tel switchboard: +45 79 32 22 00 - Fax switchboard: +45 79 32 25 80  
www.alfalaval.com





**How to contact Alfa Laval**

Contact details for all countries are continually updated on our website.

Please visit [www.alfalaval.com](http://www.alfalaval.com) to access the information directly.

© Alfa Laval Corporate AB

This document and its contents is owned by Alfa Laval Corporate AB and protected by laws governing intellectual property and thereto related rights. It is the responsibility of the user of this document to comply with all applicable intellectual property laws. Without limiting any rights related to this document, no part of this document may be copied, reproduced or transmitted in any form or by any means (electronic, mechanical, photocopying, recording, or otherwise), or for any purpose, without the expressed permission of Alfa Laval Corporate AB. Alfa Laval Corporate AB will enforce its rights related to this document to the fullest extent of the law, including the seeking of criminal prosecution.