

NOT ALL PUMPS ARE BUILT THE SAME

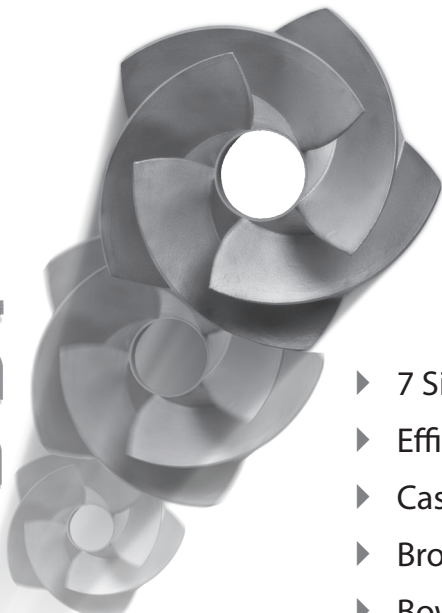

- ▶ 7 Sizes: E10HO, J11LO, J11MO, J11HO, H12HO, J12XHO, H14MO
- ▶ Efficiency To 86%
- ▶ Cast Iron Bowls
- ▶ Bronze Impellers
- ▶ Bowl Assemblies Turned To Fit PVC Casing
- ▶ Heavy Duty Castings For Longer Life
- ▶ Oil or Water Lube Construction

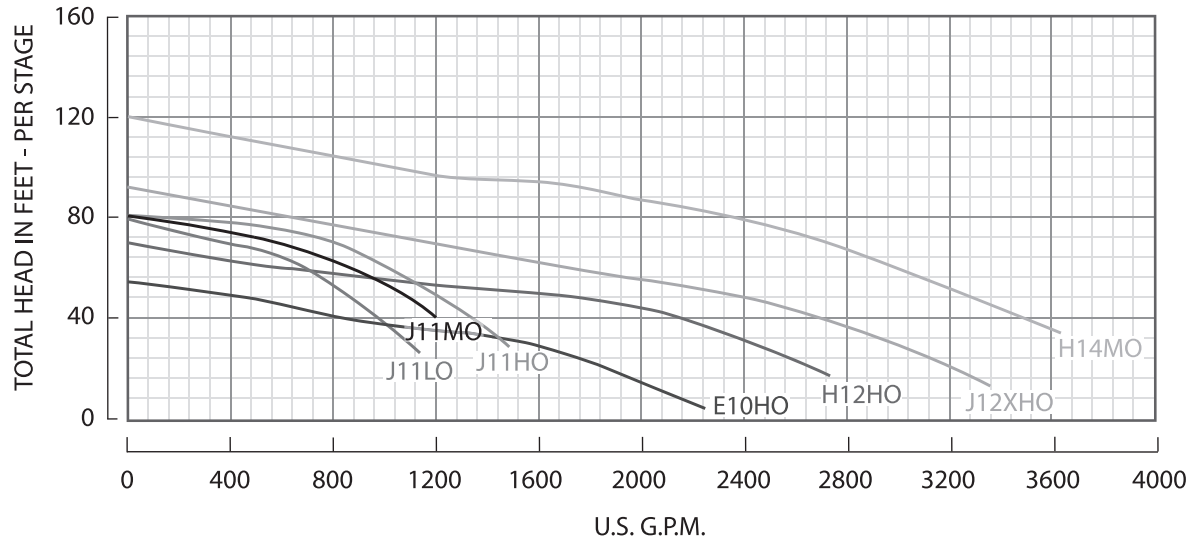
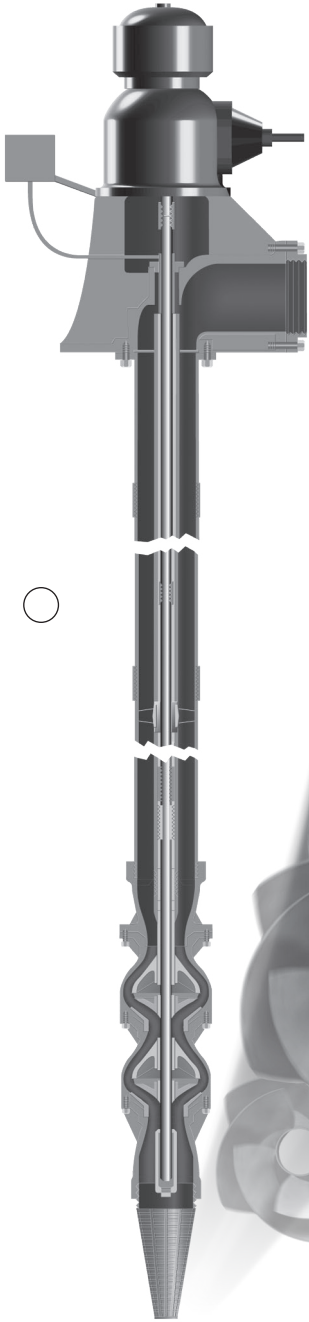
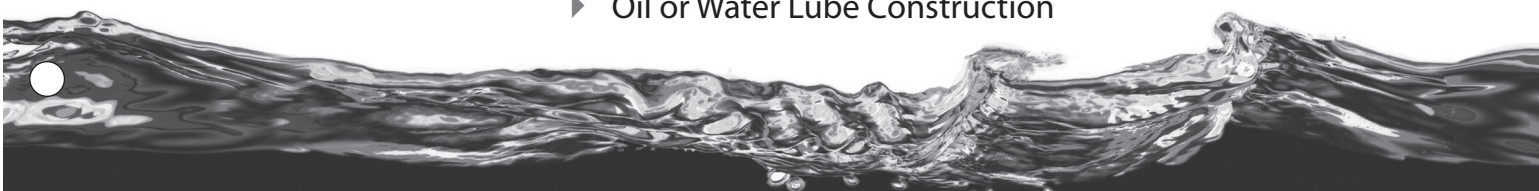

PERFORMANCE BASED ON PUMPING CLEAR, FRESH NON-AERATED WATER AT 85° F. MAXIMUM.



E10HO
1770 RPM

CHANGE EFFICIENCY AS FOLLOWS	NUMBER OF STAGES	2	3	4	5	DESIGN	G.P.M.	TDH	BPH	EFF.
	NUMBER OF POINTS	-3	-2	-1	0					

1 STG. () STG.

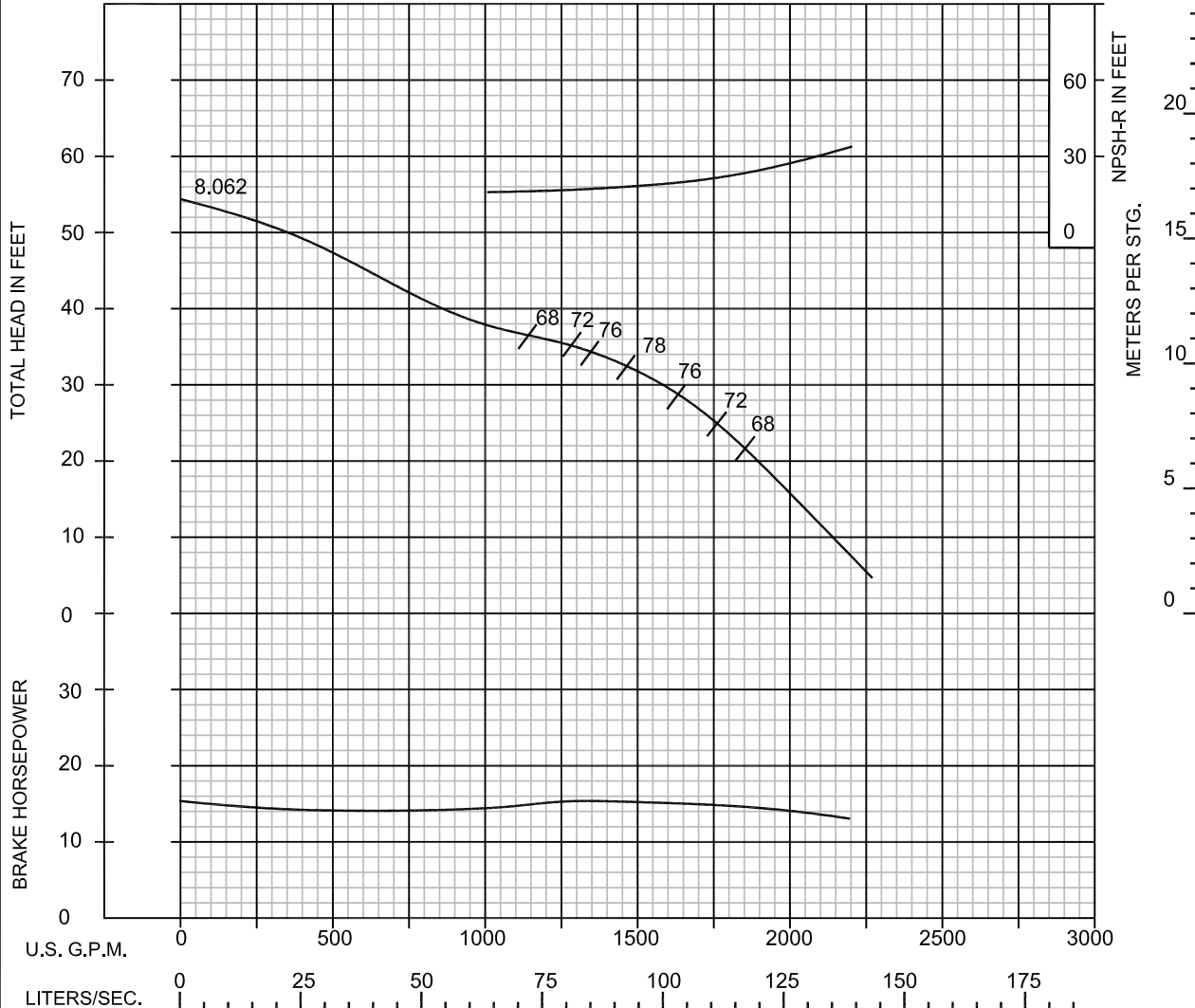

DIMENSIONS IN INCHES	A	B	C ADD/STG	E	F	G	H *	J	K	L	M	N
	9.75	6.50	9.62	8.19	9.44	1.43	22.00	10.62	N/A	N/A	N/A	24.31

PUMP DATA

IMPELLER:	SEMI-OPEN	BOWL CONNECTION:	FLANGED
NO. OF VANES:	7	DISCHARGE SIZE:	8"
THRUST CONSTANT:	10.7	SUCTION SIZE:	8"
LATERAL:	0.75	STD. TUBE:	2.50"
EYE AREA IN:	26.50	WR 2:	0.59LB.FT. ²
SHAFT DIA:	1.500	ONE STG. WT. LB:	175
		ADD STG. WT. / LBS.	70

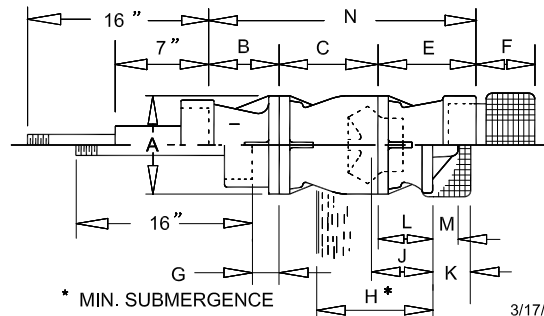

*THIS DIMENSION TO BE USED WITH NPSHR. PUMP INSTALLATION AND SYSTEM MUST SATISFY BOTH VALUES. PERFORMANCE BASED ON CAST IRON ENAMELED BOWLS AND BRONZE IMPELLERS.

* MIN. SUBMERGENCE

3/17/09
CVE10HO4P6CY

PERFORMANCE BASED ON PUMPING CLEAR, FRESH NON-AERATED WATER AT 85° F. MAXIMUM.



J11LO
1770 RPM

CHANGE EFFICIENCY AS FOLLOWS	NUMBER OF STAGES	1	3	4		DESIGN	G.P.M.	TDH	BPH	EFF.
	NUMBER OF POINTS	-4	-1	0						

1 STG. () STG.

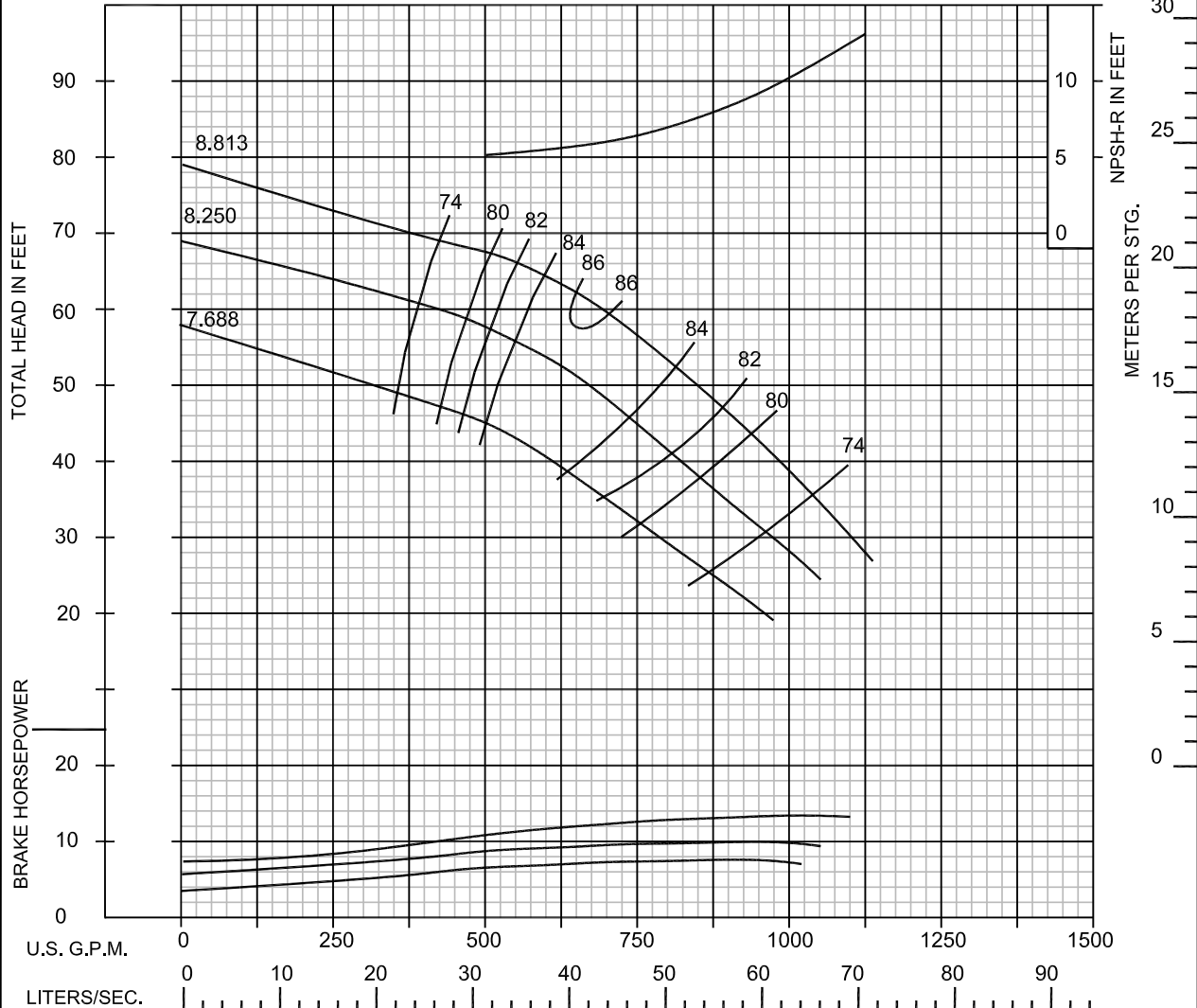

DIMENSIONS IN INCHES	A	B	C	E	F	G	H *	J	K	L	M	N
	11.125	6.81	9.875	10.00	9.44	1.56	24"	10.75	10.06	7.25	3.75	26.69

PUMP DATA

IMPELLER:	SEMI-OPEN	BOWL CONNECTION:	FLANGED
NO. OF VANES:	6	DISCHARGE SIZE:	8"
THRUST CONSTANT:	7.8	SUCTION SIZE:	8"
LATERAL:	1.00	STD. TUBE:	2.5", 3.0"
EYE AREA IN:	15.9	WR ² :	1.02 LB.FT ²
SHAFT DIA:	1.6875	ONE STG. WT. LB:	183
		ADD STG. WT. / LBS.	91

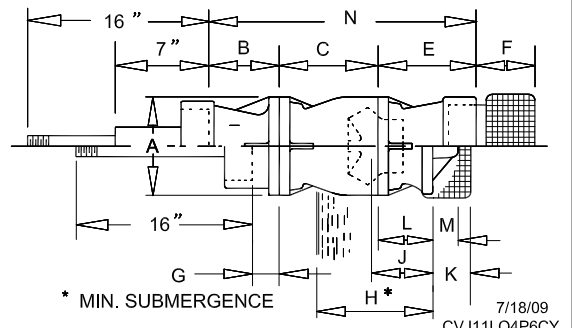

*THIS DIMENSION TO BE USED WITH NPSHR. PUMP INSTALLATION AND SYSTEM MUST SATISFY BOTH VALUES. PERFORMANCE BASED ON CAST IRON ENAMELED BOWLS AND BRONZE IMPELLERS.

7/18/09
CVJ11LO4P6CY

PERFORMANCE BASED ON PUMPING CLEAR, FRESH NON-AERATED WATER AT 85° F. MAXIMUM.

N^{PC} NATIONAL PUMP COMPANY

J11MO

1770 RPM

CHANGE EFFICIENCY AS FOLLOWS	NUMBER OF STAGES	1	3	4	DESIGN	G.P.M.	TDH	BPH	EFF.
	NUMBER OF POINTS	-4	-1	0					

1 STG. () STG.

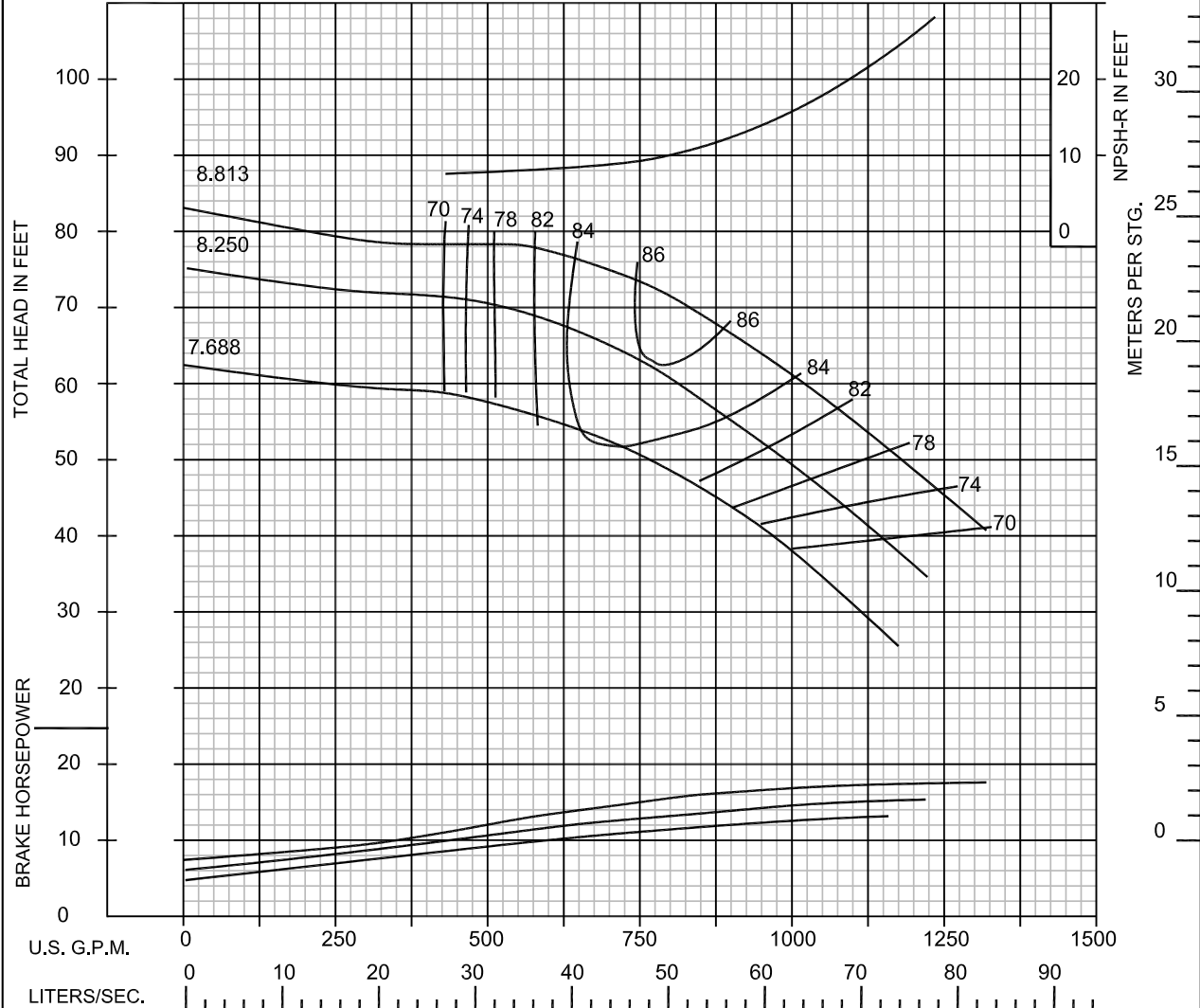

DIMENSIONS IN INCHES	A	B	C ADD/STG	E	F	G	H *	J	K	L	M	N
	11.125	6.81	9.875	10.00	9.44	1.56	24"	10.75	10.06	7.25	3.75	26.69

PUMP DATA

IMPELLER:	SEMI-OPEN	BOWL CONNECTION:	FLANGED
NO. OF VANES:	7	DISCHARGE SIZE:	8"
THRUST CONSTANT:	7.8	SUCTION SIZE:	8"
LATERAL:	1.00	STD. TUBE:	2.5", 3.0"
EYE AREA IN:	15.9	WR ² :	1.02 LB.FT ²
SHAFT DIA:	1.6875	ONE STG. WT. LB:	183
		ADD STG. WT. / LBS.	91

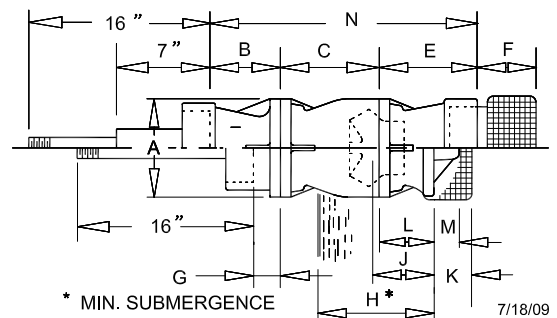

*THIS DIMENSION TO BE USED WITH NPSHR. PUMP INSTALLATION AND SYSTEM MUST SATISFY BOTH VALUES. PERFORMANCE BASED ON CAST IRON ENAMELED BOWLS AND BRONZE IMPELLERS.

7/18/09
CVJ11MO4P6CY

PERFORMANCE BASED ON PUMPING CLEAR, FRESH NON-AERATED WATER AT 85° F. MAXIMUM.

N^{PC} NATIONAL PUMP COMPANY

J11HO

1770 RPM

CHANGE EFFICIENCY AS FOLLOWS	NUMBER OF STAGES	1	3	4	DESIGN	G.P.M.	TDH	BPH	EFF.
	NUMBER OF POINTS	-4	-1	0					

1 STG. () STG.

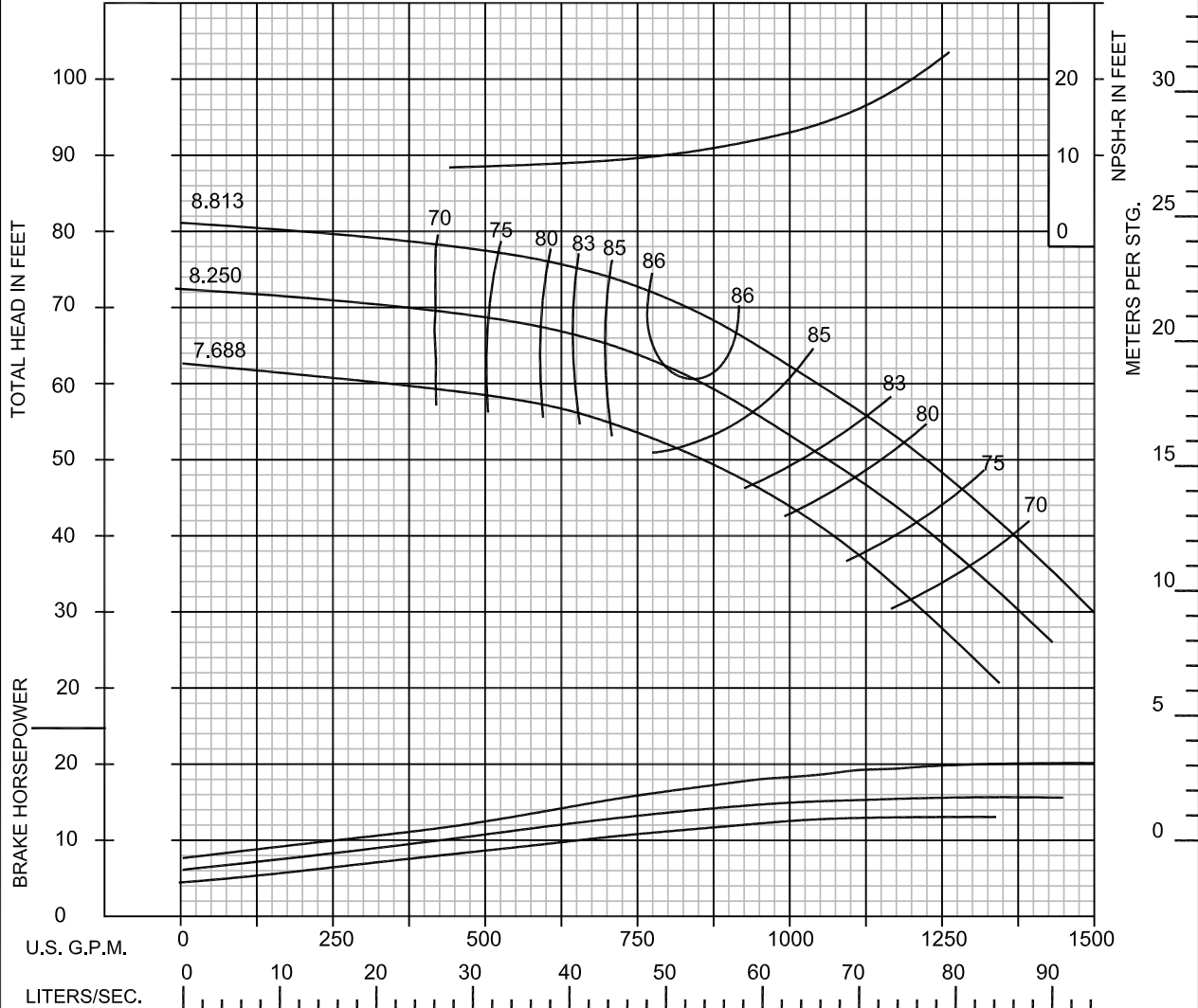

DIMENSIONS IN INCHES	A	B	C ADD/STG	E	F	G	H *	J	K	L	M	N
	11.125	6.81	9.875	10.00	9.44	1.56	24"	10.75	10.06	7.25	3.75	26.69

PUMP DATA

IMPELLER:	SEMI-OPEN	BOWL CONNECTION:	FLANGED
NO. OF VANES:	8	DISCHARGE SIZE:	8"
THRUST CONSTANT:	7.8	SUCTION SIZE:	8"
LATERAL:	1.00	STD. TUBE:	2.5", 3.0"
EYE AREA IN:	15.9	WR ² :	1.02 LB.FT ²
SHAFT DIA:	1.6875	ONE STG. WT. LB.:	183
		ADD STG. WT. / LBS.:	91

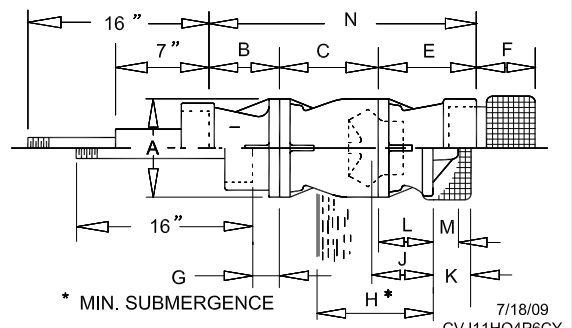

*THIS DIMENSION TO BE USED WITH NPSHR. PUMP INSTALLATION AND SYSTEM MUST SATISFY BOTH VALUES. PERFORMANCE BASED ON CAST IRON ENAMELED BOWLS AND BRONZE IMPELLERS.

7/18/09
CVJ11HO4P6CY

PERFORMANCE BASED ON PUMPING CLEAR, FRESH NON-AERATED WATER AT 85° F. MAXIMUM.

N^{PC} NATIONAL PUMP COMPANY

H12HO

1770 RPM

CHANGE EFFICIENCY AS FOLLOWS	NUMBER OF STAGES	2	3	4	5	DESIGN	G.P.M.	TDH	BPH	EFF.
	NUMBER OF POINTS	-3	-2	-1	0					

1 STG. () STG.

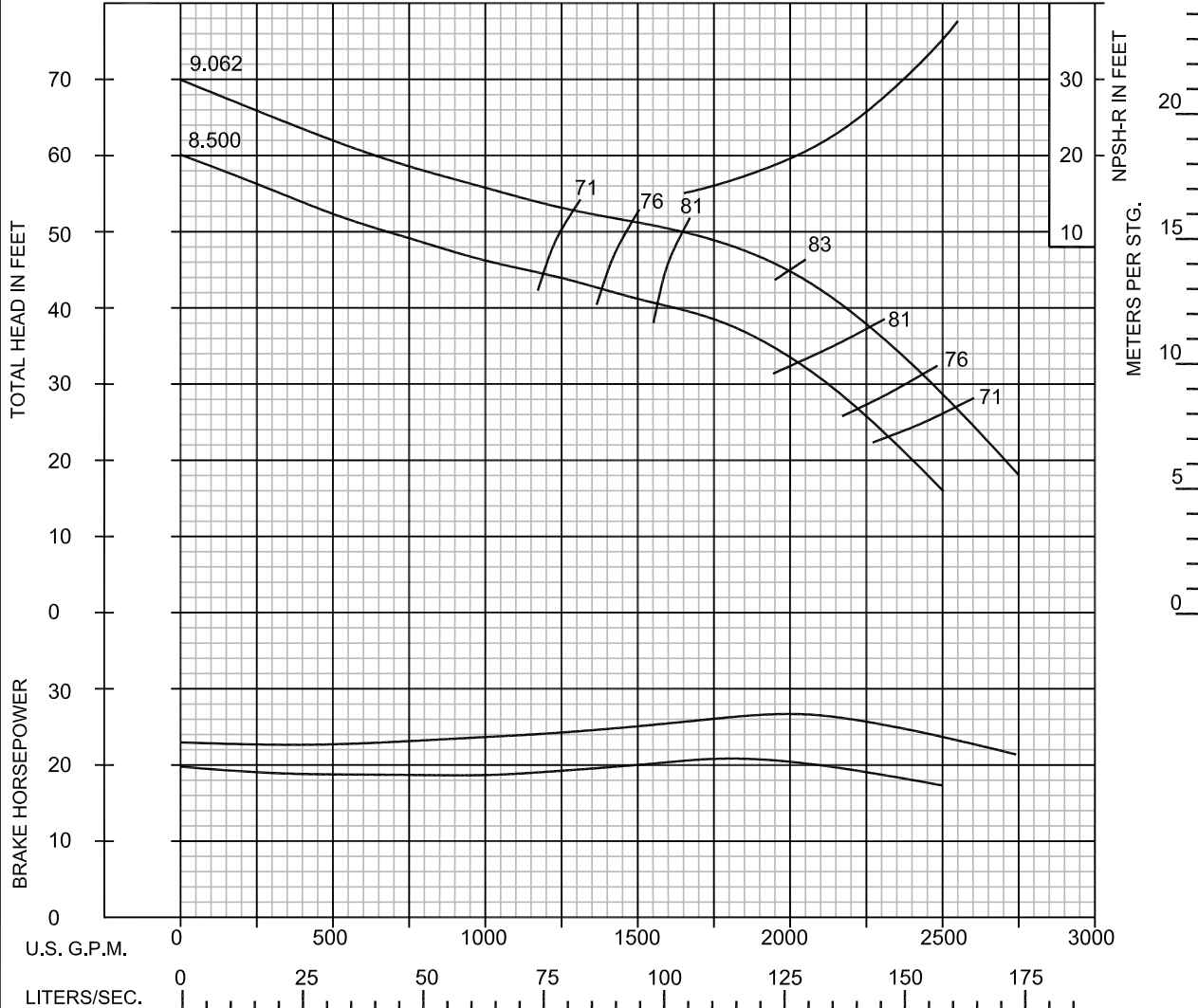

DIMENSIONS IN INCHES	A	B	C ADD/STG	E	F	G	H *	J	K	L	M	N
	11.62	6.06	12.50	12.50	11.25	1.31	28.00	13.50	N/A	N/A	N/A	31.06

PUMP DATA

IMPELLER:	SEMI-OPEN	BOWL CONNECTION:	FLANGED
NO. OF VANES:	7	DISCHARGE SIZE:	8", 10"
THRUST CONSTANT:	15.4	SUCTION SIZE:	10"
LATERAL:	1"	STD. TUBE:	2.5", 3"
EYE AREA IN:	33.4	WR ² :	2.32 LB.FT ²
SHAFT DIA:	1.6875	ONE STG. WT. LB:	375
		ADD STG. WT. / LBS.	150

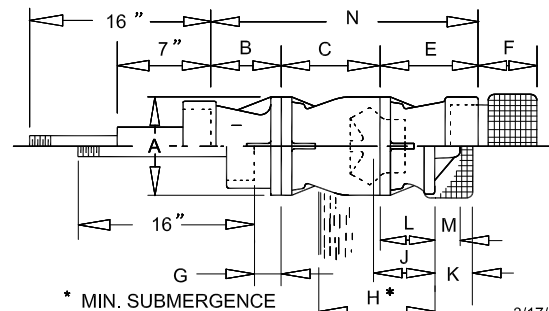

*THIS DIMENSION TO BE USED WITH NPSHR. PUMP INSTALLATION AND SYSTEM MUST SATISFY BOTH VALUES. PERFORMANCE BASED ON CAST IRON ENAMELED BOWLS AND BRONZE IMPELLERS.

3/17/09
CVH12HO4P6CY

PERFORMANCE BASED ON PUMPING CLEAR, FRESH NON-AERATED WATER AT 85° F. MAXIMUM.

N^{PC} NATIONAL PUMP COMPANY

J12XHO

1770 RPM

CHANGE EFFICIENCY AS FOLLOWS	NUMBER OF STAGES	1	2	3	5	DESIGN	G.P.M.	TDH	BPH	EFF.
	NUMBER OF POINTS	-3	-2	-1	0					

1 STG. () STG.

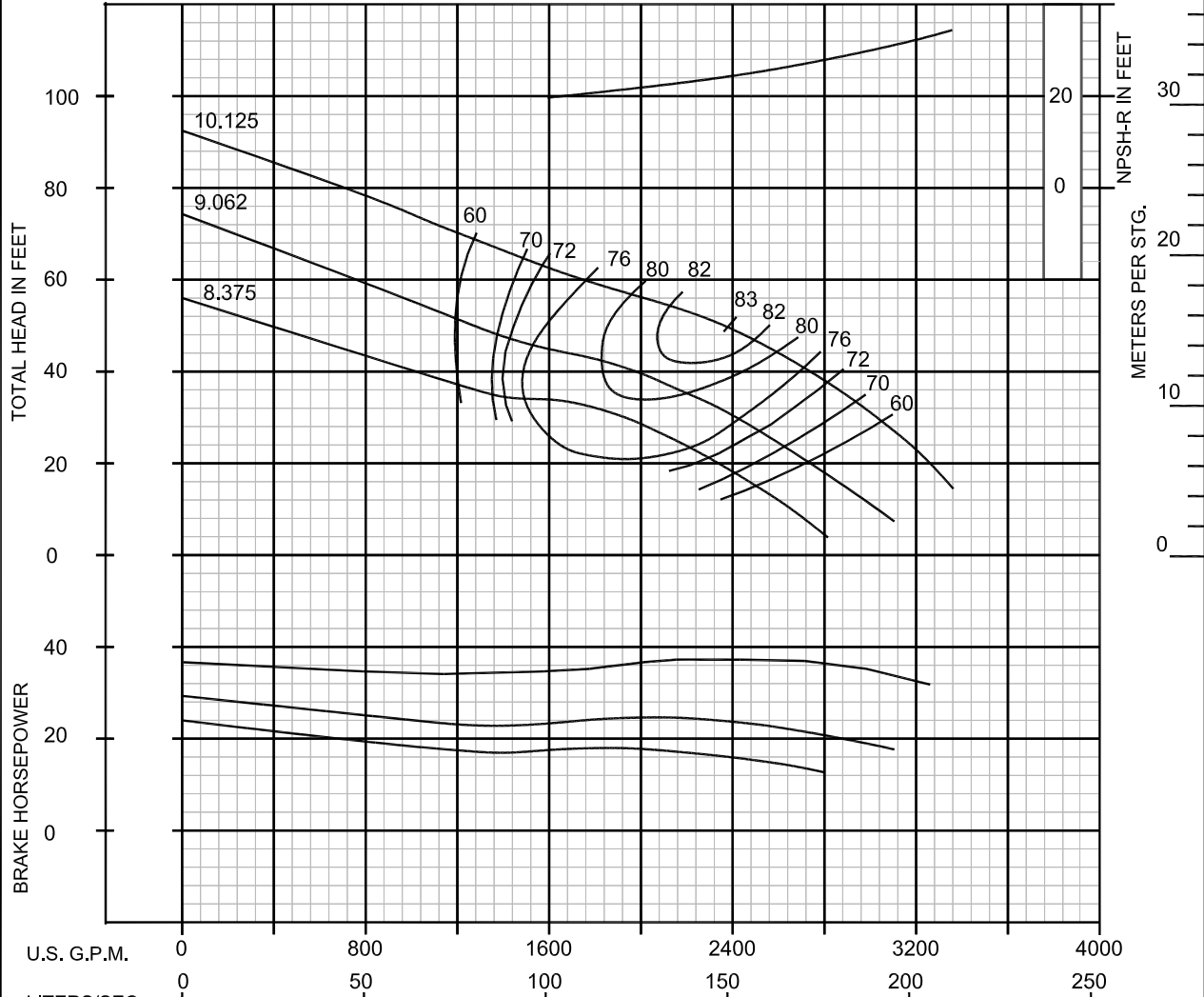

DIMENSIONS IN INCHES	A	B	C	E	F	G	H *	J	K	L	M	N
	11.75	5.81	12.38	10.00	11.25	1.62	24.00	N/A	N/A	N/A	N/A	28.19

PUMP DATA

IMPELLER: SEMI-OPEN	BOWL CONNECTION: FLANGED
NO. OF VANES: 6	DISCHARGE SIZE: 10"
THRUST CONSTANT: 15.6	SUCTION SIZE: 10"
LATERAL: 1.375	STD. TUBE: 3"
EYE AREA IN: 36.2	WR ² : 2.71 LB.FT ²
SHAFT DIA: 1.9375	ONE STG. WT./LB: 395
	ADD STG. WT./LBS: 170

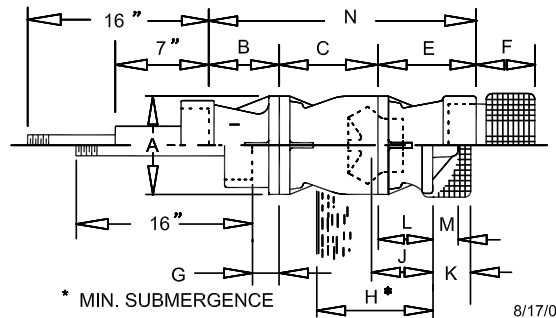

*THIS DIMENSION TO BE USED WITH NPSHR. PUMP INSTALLATION AND SYSTEM MUST SATISFY BOTH VALUES. PERFORMANCE BASED ON CAST IRON ENAMELED BOWLS AND BRONZE IMPELLERS.

8/17/09
CVJ12XHO4P6CY

PERFORMANCE BASED ON PUMPING CLEAR, FRESH NON-AERATED WATER AT 85° F. MAXIMUM.



H14MO
1770 RPM

CHANGE EFFICIENCY AS FOLLOWS	NUMBER OF STAGES	1	2	3	DESIGN	G.P.M.	TDH	BPH	EFF.
	NUMBER OF POINTS	-4	-2	0					

1 STG. () STG.

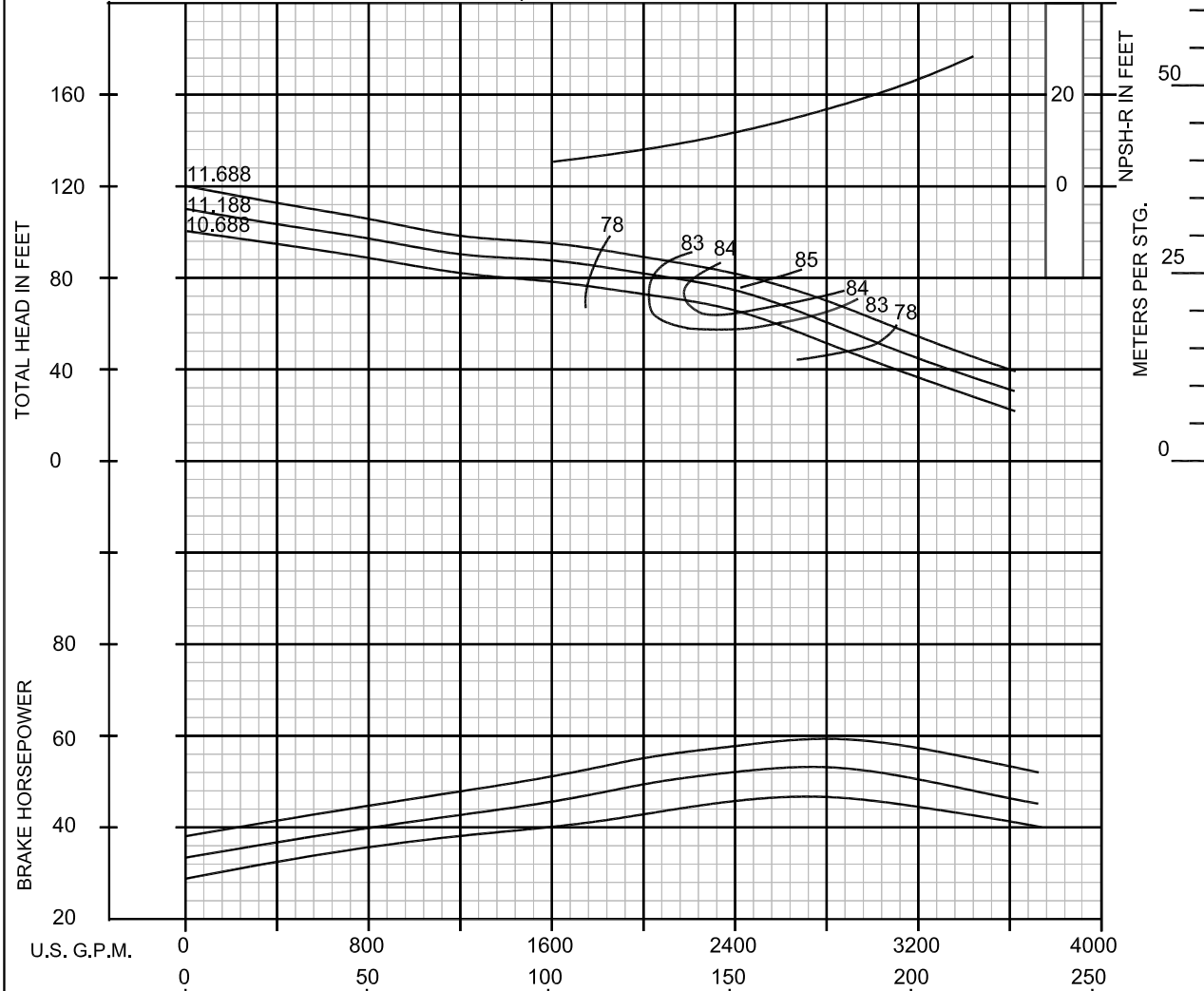

DIMENSIONS IN INCHES	A	B	C	E	F	G	H *	J	K	L	M	N
	14.12	6.44	14.12	12.25	11.25	.56	25	8.75	N/A	N/A	N/A	32.81

PUMP DATA

IMPELLER:	SEMI-OPEN	BOWL CONNECTION:	FLANGED
NO. OF VANES:	5	DISCHARGE SIZE:	10", 12"
THRUST CONSTANT:	20.3	SUCTION SIZE:	10"
LATERAL:	1.25	STD. TUBE:	3.5"
EYE AREA IN:	38.96	WR 2:	2.25 LB.FT ²
SHAFT DIA:	2.1875	ONE STG. WT. LB:	522
		ADD STG. WT./LBS.	182

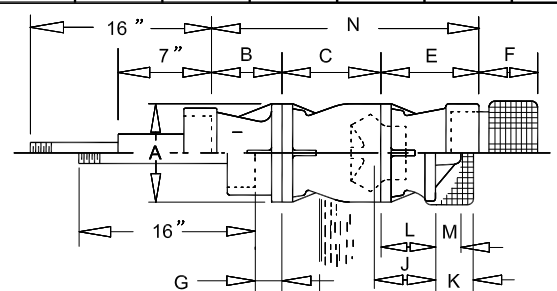

*THIS DIMENSION TO BE USED WITH NPSHR. PUMP INSTALLATION AND SYSTEM MUST SATISFY BOTH VALUES. PERFORMANCE BASED ON CAST IRON ENAMELED BOWLS AND BRONZE IMPELLERS.

* MIN. SUBMERGENCE
5/18/09
CVH14MO4P6CY

www.nationalpumpcompany.com

ARIZONA
(800) 966-5240

FLORIDA
(800) 994-3045

MISSISSIPPI
(866) 668-4914

CALIFORNIA
(800) 868-9755

GEORGIA
(800) 741-2921

TEXAS
(800) 745-5393



Corporate Office: 7706 N. 71st Ave., Glendale, AZ 85303-1703
(623) 979-3560 • Fax (623) 979-2177

OICAT 1/10