



**FINISH THOMPSON INC.**

## **SF SERIES**

### **SFM, SFM-DEF, SFP, SFV, SFVV, SFM-H, SFM-H-DEF, SFP-H, SFV-H, SFVV-H MODELS OPERATION & PARTS MANUAL**

P/N 111214 R2





**FINISH THOMPSON INC.**

921 Greengarden Road • Erie, PA 16501-1591 U.S.A.  
Ph 814-455-4478 • Fax 814-455-8518  
Email fti@finishthompson.com • www.finishthompson.com

## EU Declaration of Conformity



Finish Thompson Inc. hereby declares that the following machine(s) fully comply with the applicable health and safety requirements as specified by the EU Directives listed. The product may not be taken into service until it has been established that the drive motor for the Drum and Container Pump complies with the provisions of all relevant EU Directives. The complete product complies with the provisions of the EU Directive on machinery safety provided motors manufactured by Finish Thompson Inc. are used.

This declaration is valid provided that the devices are fully assembled and no modifications are made to these devices.

### Type of Device

Drum and Container Pump Tubes and Accessories

### Models:

BTS - 40/48	HVDP HR-27/40/48	EFP/EFV/EFS-16/27/40/48/54
HVDP LR-27/40/48	PFS-27/40/48/54/60/72	PFM-27/40/48/54/60
PFP-27/40/48/54/60/72	TBS-40	PFV-27/40/48/54/60/72
TBP-27/40/48	TMS-40	TTC/TTS-27/40/48
STTS-40	SFM/SFM-DEF/SFP/SFV/SFVV/SFS	Nozzles (111030)
	SFM-H/SFM-H-DEF/SFP-H/SFV-H/SFVV-H/SFS-H	
	27/40/48/54/60/72	

### EU Directives:

Machinery Safety (2006/42/EC)

### Applied Harmonized Standards

EN ISO 12100:2010  
EN 809 1998+A1:2009

Manufacturer: Finish  
Thompson Inc.  
921 Greengarden Road  
Erie, Pennsylvania 16501-1591 U.S.A

Signed,

President

12 September 2022

Person(s) Authorized to Compile Technical File: Finish Thompson GmbH  
Otto-Hahn-Strasse 16  
Maintal, D-63477 DEU  
Telephone: 49 (0)6181-90878-0

## Introduction

This manual pertains to the SF Series drum pumps and accessories. Finish Thompson Inc. thanks you for choosing our products. We believe the use of our products will be fully satisfactory. When properly installed and operated, your Finish Thompson motor and pump will provide long, trouble-free service; therefore, please read this manual carefully before carrying out any operations on the pump/motor unit. Any use other than that described herein is considered incorrect; and, consequently, Finish Thompson Inc. shall not be held responsible for any damages to people or property. In case of doubt or enquiries, please reply to our Technical Service department directly at the following address:

Finish Thompson, Inc.  
921 Greengarden Rd.  
Erie, PA 16501 U.S.A.  
Tel. 1-814-455-4478; Fax 1-814-455-8518  
[www.finishthompson.com](http://www.finishthompson.com); [fti@finishthompson.com](mailto:fti@finishthompson.com)

## Index

Introduction .....	3
Warranty, General Terms & Conditions .....	4
Safety.....	5
Important Safety Information for Pumping Flammable or Hazardous Substances .....	6
Specifications & Dimensions .....	7
Operation .....	8
Disassembly.....	9-10
Reassembly.....	11-12
Exploded View – SF Pump Tube .....	13
Pump Tube Spare Parts List.....	14-16

**Note:** Repair instructions can be downloaded from our web site at [www.finishthompson.com](http://www.finishthompson.com) or contact Technical Service at 1-800-888-3743.

## **Warranty, General Terms & Conditions**

Finish Thompson, Inc (manufacturer) warrants this pump product to be free of defects in materials and workmanship for a period of one year from date of purchase by original purchaser. If a warranted defect, which is determined by manufacturer's inspection, occurs within this period, it will be repaired or replaced at the manufacturer's option, provided (1) the product is submitted with proof of purchase date and (2) transportation charges are prepaid to the manufacturer. Liability under this warranty is expressly limited to repairing or replacing the product or parts thereof and is in lieu of any other warranties, either expressed or implied. This warranty does not apply to normal wear of the product or components. This warranty does not apply to products or parts broken due to, in whole or in part, accident, overload, abuse, chemical attack, tampering, or alteration. The warranty does not apply to any other equipment used or purchased in combination with this product. The manufacturer accepts no responsibility for product damage or personal injuries sustained when the product is modified in any way. If this warranty does not apply, the purchaser shall bear all cost for labor, material and transportation.

Manufacturer shall not be liable for incidental or consequential damages including, but not limited to, process down time, transportation costs, costs associated with replacement or substitution products, labor costs, product installation or removal costs, or loss of profit. In any and all events, manufacturer's liability shall not exceed the purchase price of the product and/or accessories.

## **Warranty Registration**

Thank you for your purchase of this quality Finish Thompson product. Be sure to take a minute to register your pump at [Finishthompson.com/warranty](http://Finishthompson.com/warranty). Simply provide the model number, serial number and a few other pieces of information.

# Safety

## 1. Introduction

This manual contains all the information needed for the correct installation, use and maintenance of your new Finish Thompson pump and accessories. It should be read and understood by all the personnel involved in installation, operating and servicing of the pump before it is started.

## 2. Operator Qualification and Training

The personnel in charge of the installation, the operation, and the maintenance of the pump must be qualified and able to perform the operations described in this manual. Finish Thompson, Inc. shall not be held responsible for the training level of personnel and for the fact that they are not fully aware of the contents of this manual.

## 3. Safety Instructions

### FOR YOUR OWN SAFETY

BEFORE using or servicing your pump or accessories, please make sure to wear the proper clothing, eye protection and follow standard safety procedures when handling corrosive or personally harmful materials.

### GENERAL DANGER

**NEVER** use a plastic pump, plastic accessory, or an open, splash-proof, TEFC or non-ATEX motor when pumping or mixing flammable or combustible material.

**ALWAYS** ensure the pump, hose, and motor are bonded to ground, and the tanks/containers are separately bonded to ground.

**ALWAYS** inspect the integrity of the ground wire connections prior to each use.

**NEVER** leave the pump unattended while in use.

**NEVER** run the pump dry without fluid.

**NEVER** run the pump with a closed valve (deadhead) for longer than 1 minute.

**ALWAYS** use and store the pump and motor in an upright position.

**NEVER** use in pressurized containers.

**ALWAYS** use a chemically compatible hose rated for the temperature of the product being pumped.

**ALWAYS** tighten and torque a stainless steel hose clamp to 25 in-lbs (2.8 N·m)

**ALWAYS** select the proper o-ring material. Improper material selection could lead to swelling and be a possible source of leaks. This is the responsibility of the end user.

**ALWAYS** check the pump for leaks on a regular basis. If leaks are noticed, the pump must be repaired or replaced immediately.

### DANGER: POWER SUPPLY

Refer to instructions in the appropriate motor Operation & Installation Manual.

## 4. Noise Level

Refer to specifications in the appropriate motor Operation & Installation Manual.

## 5. Modifications and Spare Parts

Any changes concerning the service of the pump or accessory as originally purchased can be executed only after written approval from Finish Thompson Inc. It is recommended to use only genuine Finish Thompson Inc. spare parts and approved accessories. The use of non-original spare parts or non-approved accessories will void warranty and removes any responsibility on the manufacturer's behalf for any damage caused to people or things.

## 6. Cleaning

It is highly recommended to flush pumps and accessories with clean water or some other neutralizing fluid compatible with pump materials when done pumping or when switching chemicals.

## IMPORTANT SAFETY INFORMATION FOR PUMPING FLAMMABLE OR HAZARDOUS SUBSTANCES

Read these instructions before operating the pump and motor equipment. The manufacturer will not be responsible for any damage to property or to persons caused by improper use of the equipment.

- ⚠ WARNING:** It is the responsibility of the user to operate the pump in conformance with OSHA rules for dispensing liquids. Pump containers should be grounded when using with flammable or combustible liquids to avoid static electricity.
1. Use only an explosion-proof rated electric or non-electric (air) motors on stainless steel pump tubes with a Static Protection Kit when transferring flammable or combustible liquids.
- ⚠ WARNING:** Never use an open, splash-proof, TEFC, battery-operated or non-explosion-proof rated motor or a plastic pump tube when transferring flammable or combustible liquids.
2. When operating a drum pump (especially when pumping flammable, combustible or hazardous liquids) follow all electrical and safety codes.
    - a) In the United States: the United States Occupational Safety and Health Act (OSHA), most recent National Electrical Code (NEC), National Fire Protection, Inc. (NFPA) Code 30 (Flammable and Combustible Code), NFPA 77 (Static Electricity), NFPA 251 (Standard Method of fire Test of Building Construction), NFPA 704 (Identification of the Fire Hazards of Materials), and other NFPA codes, local codes and ordinances.
    - b) Outside the United States: the ATEX equipment directive 2014/34/EU where applicable, the ATEX workplace 99/92/EC directive where applicable, in addition the precautions of the U.S. codes listed herein and all other local codes and ordinances.
  3. Pumping hazardous, flammable, or combustible liquids should only be done in buildings, rooms, or areas suited for this purpose. (See NFPA 30, NFPA 78, NFPA 80, NFPA 251, NFPA 704, other suitable NFPA codes, OSHA, ATEX workplace 99/92/EC directive insurance companies, and other local codes and ordinances.)
  4. When filling cans, drums, etc. with combustible or flammable liquids, both container pumping from and container pumping to, should be bonded and grounded to dissipate possible accumulations of static electricity, and minimize sparks caused by static electricity (refer to NFPA 77 and CLC/TR 60079-32-1 for specific details).
- ⚠ WARNING:** Avoid splashing. Splash filling can create static electricity and is extremely hazardous. Reduce motor speed to prevent splashing.
- ⚠ WARNING:** Fluid velocity must be 3 feet/.9 meter/second maximum (7 gpm/26.5 lpm in 1" hose and 4 gpm/15 lpm in ¾" hose) to reduce risk of static electricity. Reduce motor speed to reduce the fluid velocity.
5. Before using, confirm that the pump and any accessories (hose, nozzle, flow meter, etc.) materials of construction are suitable for the material to be pumped and that the maximum temperature is not exceeded.

## INFORMATIONS IMPORTANTES SUR LA SÉCURITÉ DURANT LE POMPAGE DE SUBSTANCES INFLAMMABLES OU DANGEREUSES

Veuillez lire attentivement ces instructions avant d'utiliser la pompe et l'équipement du moteur. Le fabricant ne sera pas tenu responsable des dommages matériels ou corporels causés par une utilisation inappropriée de l'équipement.

- ⚠ AVERTISSEMENT:** Il est de la responsabilité de l'utilisateur de faire fonctionner la pompe conformément aux règles OSHA (Santé et Sécurité au Travail) relatives à la distribution de liquides. Les conteneurs de pompes doivent être électriquement mis à la terre lors de l'utilisation de liquides inflammables ou combustibles afin d'éviter toute électricité statique.
1. Lors du transfert de liquides inflammables ou combustibles, utilisez uniquement des moteurs électriques ou non électriques (pneumatiques) antidéflagrants sur des tubes de pompe en acier inoxydable dotés d'un dispositif de protection antistatique.
- ⚠ AVERTISSEMENT:** N'utilisez jamais de moteur ouvert, à l'épreuve des éclaboussures, TEFC, alimenté par piles ou non antidéflagrant, ni un tube de pompe en plastique lors du transfert de liquides inflammables ou combustibles.
2. Lors de l'utilisation d'une pompe à tambour (en particulier lors du pompage de liquides inflammables, combustibles ou dangereux), respectez tous les codes électriques et les codes de sécurité.
    - a) Aux États-Unis : Loi américaine sur la sécurité et la santé au travail (OSHA); le code national de l'électricité (NEC) le plus récent; le code 30 de la NFPA (code d'inflammabilité et de produits combustibles); le code NFPA 77 (électricité statique); le code NFPA 251 (Méthode standard de test d'incendie de la construction de bâtiments); le code NFPA 704 (Identification des risques d'incendie des matériaux) et autres codes et règlements de la NFPA.
    - b) En dehors des États-Unis : La directive sur les équipements ATEX 2014/34 / EU, le cas échéant, la directive ATEX sur le lieu de travail 99/92 /EC, le cas échéant, ainsi que les précautions des codes des États-Unis énumérés dans la présente et de tous les autres codes, lois et règlements locaux.
  3. Le pompage de liquides dangereux, inflammables ou combustibles ne doit être effectué que dans des bâtiments, des pièces ou des zones adaptées à cet usage. (Voir NFPA 30, NFPA 78, NFPA 80, NFPA 251, NFPA 704, autres codes NFPA appropriés, OSHA, les directives des compagnies d'assurance ATEX 99/92 /CE, et autres codes, lois et règlements locaux.)
  4. Lors du remplissage de bidons, fûts, etc. avec des liquides combustibles ou inflammables, les conteneurs d'où le liquide est pompé et le conteneur recevant le liquide doivent être reliés et mis à la terre pour éviter toute accumulation éventuelle d'électricité statique et minimiser ainsi les étincelles causées par l'électricité statique (voir NFPA 77). et CLC / TR 60079-32-1 pour des détails spécifiques).
- ⚠ AVERTISSEMENT:** Évitez les éclaboussures. Les éclaboussures peuvent créer de l'électricité statique et sont extrêmement dangereuses. Réduisez la vitesse du moteur pour éviter les éclaboussures.
- ⚠ AVERTISSEMENT:** La vitesse du fluide doit être au maximum de 3 pieds / 0,9 mètre / seconde (7 gpm / 26,5 lpm dans un tuyau de 1"; et 4 gpm / 15 lpm dans un tuyau de ¾") afin de réduire le risque d'électricité statique. Réduisez la vitesse du moteur afin de réduire ainsi la vitesse du fluide.
5. Avant utilisation, assurez-vous que les matériaux de la pompe et des accessoires (tuyau, ajutage, débitmètre, etc.) sont compatibles avec le fluide et que la température maximale n'est pas dépassée.

PUMP SPECIFICATIONS					
	MODEL SFM	MODEL SFM-DEF	MODEL SFP	MODEL SFV	MODEL SFVV
Outer Tube Diameter	1-5/8" (41mm)	1-5/8" (41mm)	1-5/8" (41mm)	1-5/8" (41mm)	1-5/8" (41mm)
Discharge Spout	1" (25mm) Barb	3/4" (19mm) Barb	1" (25mm) Barb	1" (25mm) Barb	1" (25mm) Barb
Discharge Thread	1-1/4" BSPP	1-1/4" BSPP	1-1/4" BSPP	1-1/4" BSPP	1-1/4" BSPP
Max. Specific Gravity	2.0	2.0	2.0	2.0	2.0
Max. Viscosity	1200 cP	1200 cP	1200 cP	1200 cP	1200 cP
Min./ Max. Fluid Temperature	35°F (1.7°C) Min.	35°F (1.7°C) Min.	35°F (1.7°C) Min.	35°F (1.7°C) Min.	35°F (1.7°C) Min.
	175°F (79°C) Max.	175°F (79°C) Max.	175°F (79°C) Max.	175°F (79°C) Max.	140°F (60°C) Max.
Wetted Materials	Polypro, FKM, PTFE, 316SS	Polypro, EPDM, PTFE, 316SS	Polypro, FKM, PTFE, Alloy 625	Polypro, ETFE, FKM, PTFE, Alloy 625	PVDF, ETFE, FKM, PTFE, Alloy 625

\* SFV-54, SFV-60, SFV-72: 140°F (60°C) Max. SFVV-54, SFVV-60, SFVV-72: 115°F (46°C) Max.

**MV MOTORS**

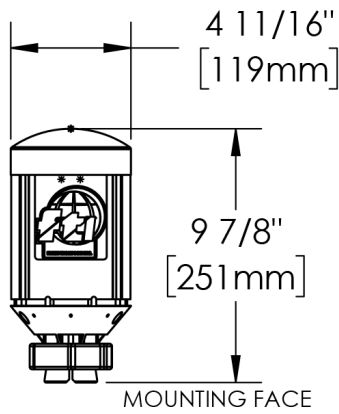

**M6 & M6A AIR MOTORS**

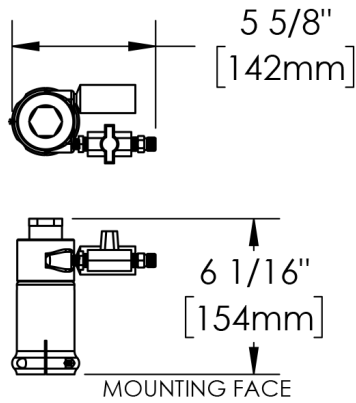

**MV MOTOR SHOWN ON PUMP**

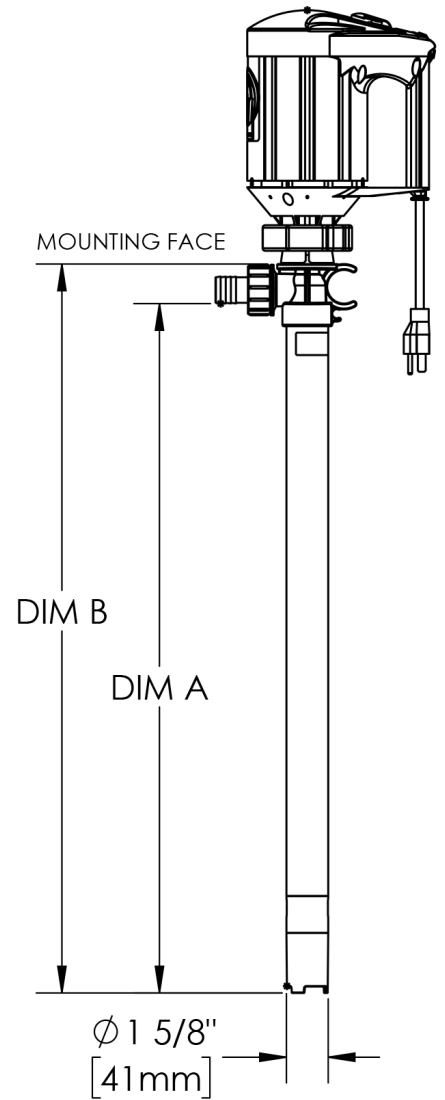

**TEFC & EXP MOTORS**

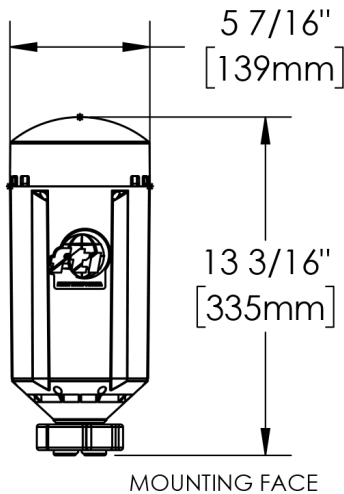

MODEL	DIM A	DIM B
SFM/SFP/SFV/SFVV-27	26 7/8" (683mm)	28 7/16" (722mm)
SFM/SFP/SFV/SFVV-40	39 7/8" (1013mm)	41 7/16" (1053mm)
SFM/SFP/SFV/SFVV-48	47 7/8" (1216mm)	49 7/16" (1256mm)
SFM/SFP/SFV/SFVV-54	53 7/8" (1368mm)	55 7/16" (1408mm)
SFM/SFP/SFV/SFVV-60	59 1/2" (1511mm)	61" (1549mm)
SFM/SFP/SFV/SFVV-72	72 9/16" (1843mm)	74 1/8" (1883mm)

# OPERATION

1. Make sure the motor (electric or air) is properly installed on the pump tube and is in the off position. See motor instruction manual for installation instructions.
2. Insert the pump tube into the fluid to be dispensed and the hose into the container to be filled prior to starting the pump. Bung adapters are available to provide a tighter fit between the pump tube and bung opening of a standard drum. Check drum pump accessories at [www.finishthompson.com](http://www.finishthompson.com) or contact your local Finish Thompson distributor for bung adapter info.
3. Make sure the pump's discharge hose is properly secured before operating the motor, torque Finish Thompson hose clamps to 25 in-lbs(2.8 N·m).
4. Begin pumping by turning the motor on and verifying that there are no leaks. If leaks are noticed immediately turn the motor off and check all discharge hose connections.

**NEVER** allow the pump to run dry.

**NEVER** pump liquids containing solids that can damage internal pump parts (i.e. metal chips). Pumping solids can lead to increased wear.

## Hose & Cord Storage

SF model pumps have a built-in hose & cord clip. You can use these clips to store your hose and keep the plug off the floor, free of damage and corrosion. When selecting a discharge hose, you should use a 1" ID reinforced chemically compatible hose secured with a stainless steel hose clamp. See figures A and B below.

Figure A

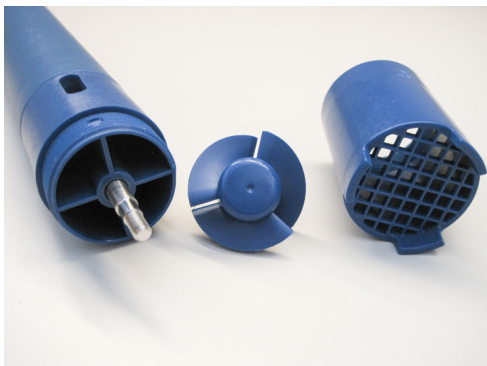

Figure B



## Choice of two types of Impellers

The SF-Series pump models can be ordered with either a "High Flow" or "High Head" impeller. The high flow impeller utilizes an axial design impeller and built in strainer/diffuser cover for quickly dispensing fluids from drums & totes. The high head impeller utilizes a centrifugal design impeller to produce high head for dispensing through long hose runs or to overcome high system pressures. Either impeller can be used with the same pump but it is important to use the correct diffuser cover to attain the proper performance. See figures below.



High Flow Impeller

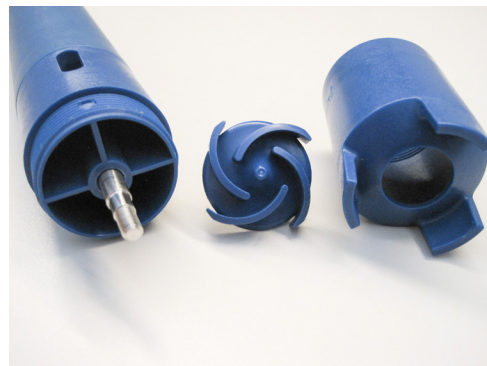

High Head Impeller



# DISASSEMBLY & REASSEMBLY INSTRUCTIONS

## Disassembly

- 1. Cover, Impeller, & Diffuser Removal** - Unthread the diffuser cover (item 19 or 20). Turn it clockwise (left-hand thread). *See Figure 1 A & B.* Unthread the impeller (item 18) turning it counter clockwise (right hand thread) using your hand while holding the coupling insert and coupling (items 1 & 2) with the other hand. *See Figure 2 A & B.* Note: If the shaft unthreads from the coupling, use a pliers to hold the bottom of the shaft just above the impeller. *See figures 3 A & B.* For longer 40" to 72" pump lengths, two people may be required to hold the shaft and unthread the impeller.
- 2. Shaft Removal** - To remove the shaft (item 5), tap the bottom of the shaft on a piece of wood or plastic and push the shaft up and out of the head (item 7). *See Figure 4 A & B.* Grab the half coupling or bearing and pull the shaft assembly straight out of the head. Note: Take care to not bend the shaft. **Important** - The shaft should only be removed if the bearing is frozen and needs to be replaced. Hold the pump shaft (item 5) with a pliers or vise grip. Turn the half coupling (item 2) counter clockwise (right hand thread) to remove it from the shaft. Be careful not to lose the spacer bushing (item 3). The bearing (item 4) will slide off the shaft. *See Figure 5 A, B, and C.* If the bearing is frozen or corroded to the shaft use a penetrating fluid and socket to help tap it off. Install a new bearing (item 4), reuse the spacer bushing (item 3) and hand tighten the half coupling (item 2). These items will only fit properly on one end of the shaft.

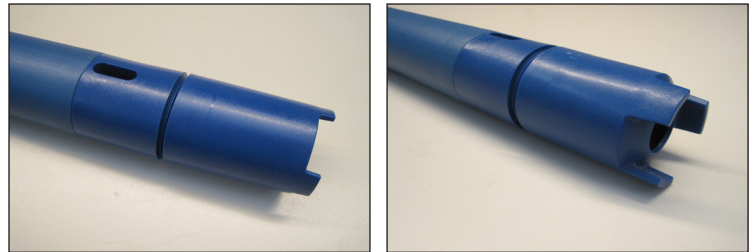

Figure 1 A & B

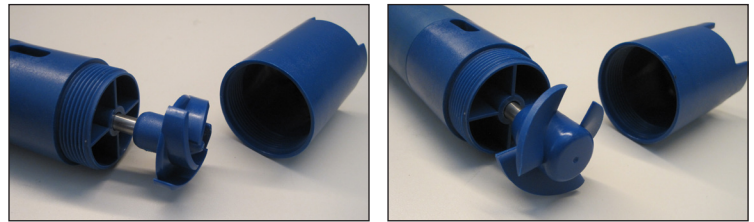

Figure 2 A & B

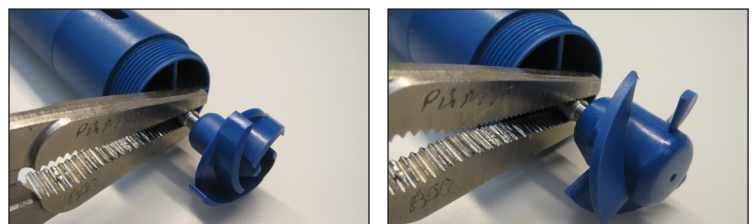

Figure 3 A & B



Figure 4 A & B

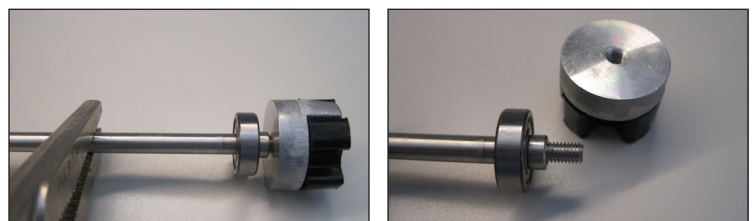

Figure 5 A, B, C

## Disassembly Continued

3. **Intake Tube Removal** - Unthread the diffuser (item 16) turning it clockwise (left-hand thread). The shaft sleeve (item 14) will drop out of the inner tube by holding it in a vertical position. Remove the intake tube (item 15). Hold the head (item 7) in one hand and with the other hand, turn the intake tube clockwise (left-hand thread). When completely unthreaded, pull the intake tube away from the head exposing the inner tube and center support (items 12 & 13) See *Figure 6 A, B, C, D, & E*.
4. **Inner Tube & Center Support Removal** - To remove the inner tube and center support, turn the inner tube to unseat the o-rings (item 11) and then pull the inner tube away from the head. See *Figure 7 A & B*.
5. **Center Support Removal** - If the center support (item 13) needs to be replaced, it can be removed by spreading open the fingers and disengaging it from the inner tube. To reinstall open the center support in the same manner as removing and slide it over the bottom of the inner tube. Then slide it up until it snaps into the machined groove. Make sure the taper is pointing downward. See *Figure 8 A, B, & C*.
6. **Seal Removal** - To remove the seal (item 4) from the head (item 7), use a hook tool, available at most hardware stores, to pull the seal out from the top of the head. Take care not to damage the seal seat area. See *figures 9 A & B*. Note: The seal should be replaced if worn or the bearing is failing or frozen.

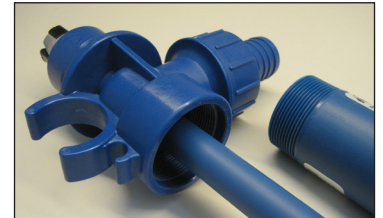
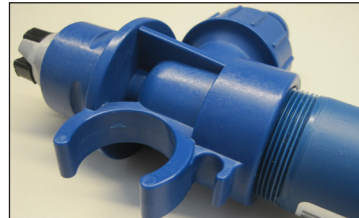
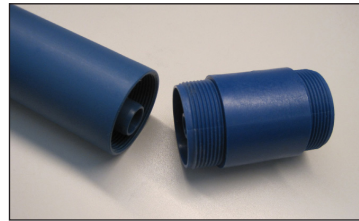
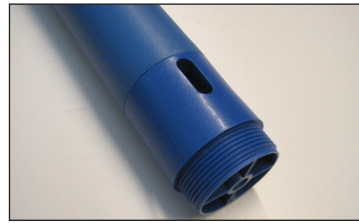

Figure 6 A, B, C, D, & E

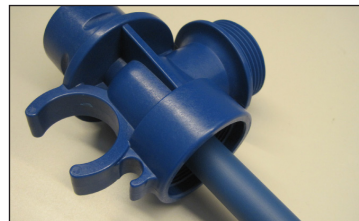

Figure 7 A & B

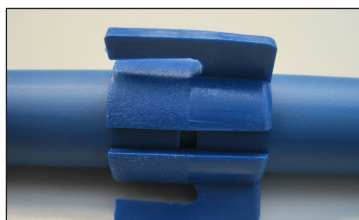
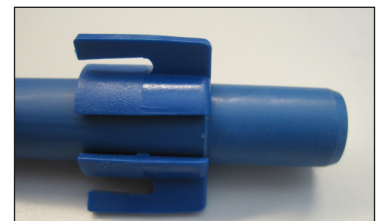
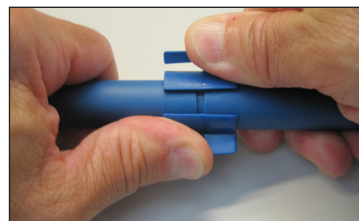

Figure 8 A, B, & C

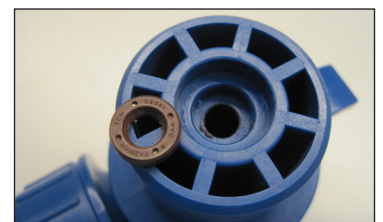
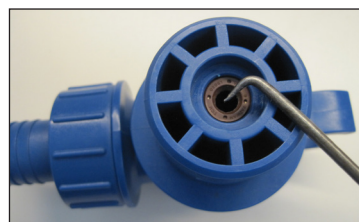

Figure 9 A & B

## Reassembly

- 1. Seal Installation** - Take the head (item 7), and install a new seal (item 4). It is recommended to lubricate the seal with a compatible lubricant or water prior to pressing it in. Insert the open part of the seal into the lower bore of the head. Use a 7/16" (12 mm) dowel to press and seat the seal into place. Seal sits slightly below the surface. See figures 10 A, B, & C. Note: never reuse an old lip seal.

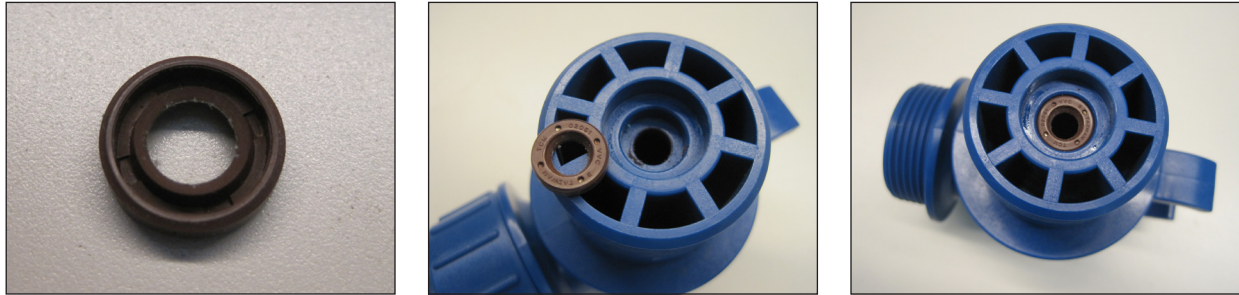

Figure 10 A, B, & C

- 2. Inner Tube & Center Support Installation** - Reinstall the inner tube, center support (items 12 & 13). Reinstall the inner tube with center support. The double o-ring side seats up into the head with a slight twisting motion. Make sure the inner tube is seated properly. It is recommended to use a compatible lubricant or water on the o-rings. See figures 11 A & B.

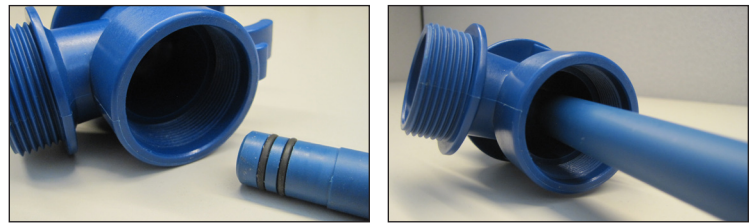

Figure 11 A & B

- 3. Intake Tube Installation** - Install the intake tube (item 5). Make sure the center support is installed correctly on the inner tube. The center support has a slight taper that allows the outer tube to slide easily over it. Slide the intake tube with external threads over the inner tube and center support up into the head (item 7). Turn the intake tube counter clockwise (left hand thread) to tighten it into the head. Hand tighten. The bottom of the inner tube will be recessed slightly with the bottom of the outer tube when properly seated. See figures 12 A, B & C.

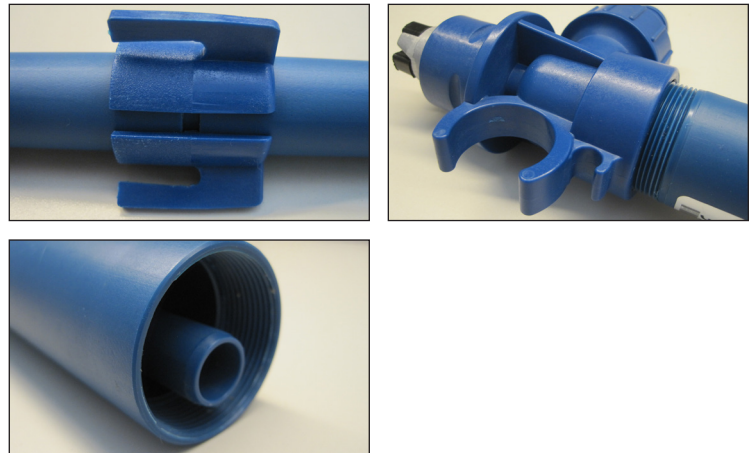

Figure 12 A, B, & C

- 4. Reinstall** the half coupling, spacer bushing, bearing and shaft (items 2, 3, 4, & 5 indicated on the Exploded View Drawing) as an assembly into the head. If the bearing needs to be replaced see section 2 of the disassembly instructions on the prior page. See figures 13 A & B.

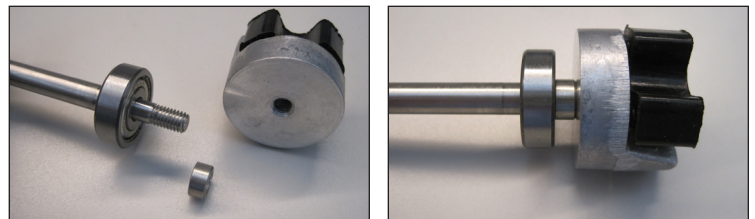

Figure 13 A & B

## Reassembly Continued

5. **Shaft Installation** - Slide the shaft down through the seal until the bearing engages the bearing bore in the head. Set the half coupling on the floor and push the pump down using the intake tube (item 15) for leverage. Make sure the bearing (item 4) is flush with the top of the head (item 7). While the pump is in this upright position slide the shaft sleeve (item 14) between the shaft (item 5) and inner tube (item 12). The shaft sleeve is self positioning so just push it in all the way until it drops down completely into the inner tube. See figures 14 A, B, C, D.

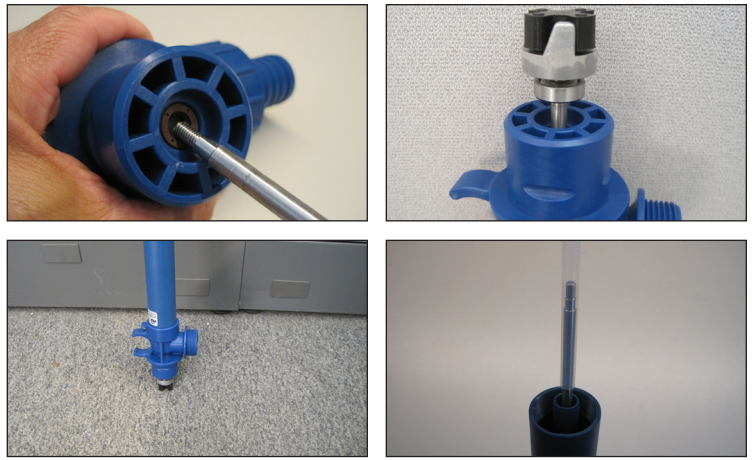

Figure 14 A, B, C, D

6. **Diffuser Installation** - Install the diffuser (item 16) onto the bottom of the outer tube. This is a tight fit so it is recommended to use a compatible lubricant or water. Insert the shaft through the small support opening on the diffuser. The small support opening will insert up inside the inner tube (item 12). With a slight push and turn, thread the diffuser into the outer tube (item 15) turning counter clockwise (left hand thread). See figures 15 A, B, & C.

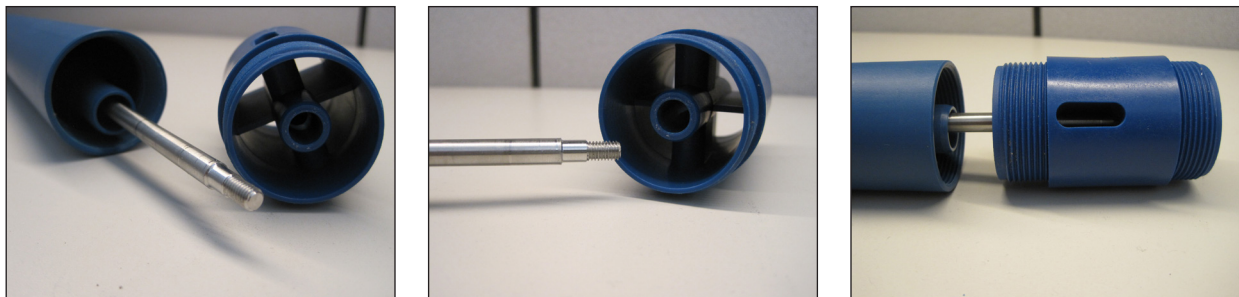

Figure 15 A, B, & C

7. Thread the diffuser (item 6) completely onto the bottom of the outer tube (item 5). Hand tighten. Thread the impeller (items 17 or 18) onto the shaft by hand. While holding the half coupling with the other hand, turn the impeller clockwise (right hand thread). Install the diffuser cover (item 19 or 20) onto the diffuser turning counter clockwise (left hand thread). Hand Tighten. See Figures 16 A, B, C, D, E, F, & G.

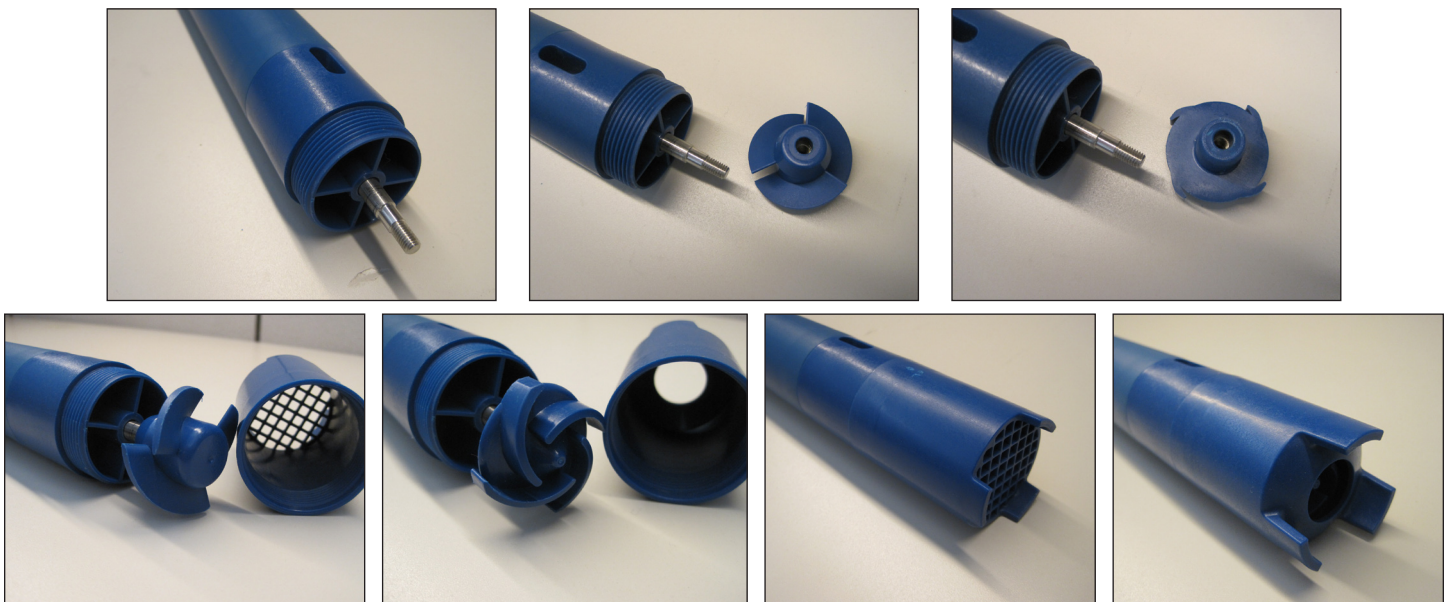
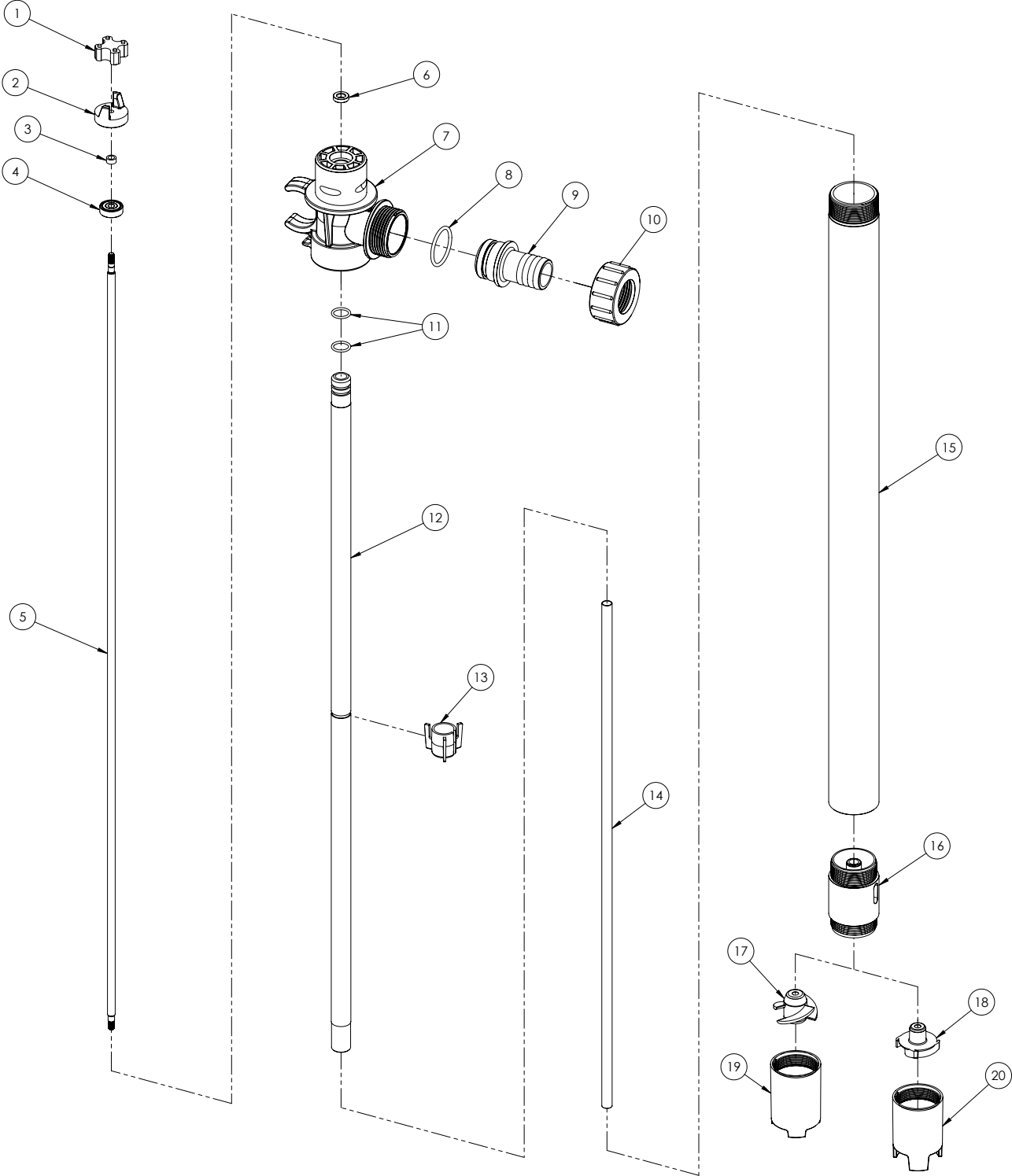

Figure 16 A, B, C, D, E, F, & G

**SF SERIES PUMP  
EXPLODED VIEW**



### PUMP SPARE PARTS LIST

ITEM	QTY	DESCRIPTION	PART NUMBER				
			MODEL SFM	MODEL SFM-DEF	MODEL SFP	MODEL SFV	MODEL SFVV
*1	1	<b>COUPLING INSERT</b>					
			J100014	J100014	J100014	J100014	J100014
2	1	<b>COUPLING HALF</b>					
			111058	111058	111058	111058	111058
3	1	<b>SPACER BUSHING</b>					
			111201	111201	111201	111201	111201
*4	1	<b>BEARING</b>					
			111057	111057	111057	111057	111057
5	1	<b>SHAFT (SFM/SFM-DEF = 316SS) (SFP/SFV/SFVV = ALLOY 625)</b>					
		27"	111202-1	111202-1	111202-2	111202-2	111202-2
		40"	111202-3	111202-3	111202-4	111202-4	111202-4
		48"	111202-5	111202-5	111202-6	111202-6	111202-6
		54"	111202-7	111202-7	111202-8	111202-8	111202-8
		60"	111202-9	111202-9	111202-10	111202-10	111202-10
		72"	111202-11	111202-11	111202-12	111202-12	111202-12
*6	1	<b>SEAL</b>					
		FKM (STANDARD)	107592	107592	107592	107592	107592
7	1	<b>HEAD</b>					
		POLYPROPYLENE	111203-1	111203-1	111203-1	N/A	N/A
		PVDF	N/A	N/A	N/A	111203-2	111203-2
*8	1	<b>O-RING, DISCHARGE SPOUT</b>					
		FKM	109526	N/A	109526	109526	109526
		EPDM	N/A	109525	N/A	N/A	N/A
9	1	<b>DISCHARGE SPOUT</b>					
		POLYPROPYLENE, 1" BARB-STANDARD	111204-1	N/A	111204-1	N/A	N/A
		POLYPROPYLENE, 3/4" BARB-STANDARD	N/A	111367-1	N/A	N/A	N/A
		POLYPROPYLENE, 1" MNPT KIT (INCLUDES NUT)-OPTIONAL	111376-1	111376-1	111376-1	N/A	N/A
		POLYPROPYLENE, 3/4" MGHT (GARDEN HOSE FITTING) - OPTIONAL	111377-1	111377-1	111377-1	N/A	N/A
		PVDF, 1" BARB-STANDARD	N/A	N/A	N/A	111204-2	111204-2
		PVDF, 3/4" BARB-OPTIONAL	N/A	N/A	N/A	111367-2	111367-2
		PVDF, 1" MNPT KIT (INCLUDES NUT)-OPTIONAL	N/A	N/A	N/A	111376-2	111376-2
PVDF, 3/4" MGHT(GARDEN HOSE FITTING) - OPTIONAL	N/A	N/A	N/A	111377-2	111377-2		
10	1	<b>NUT</b>					
		POLYPROPYLENE	111205-1	111205-1	111205-1	N/A	N/A
		PVDF	N/A	N/A	N/A	111205-2	111205-2
*11	2	<b>O-RING, INNER TUBE</b>					
		VITON	J100249	N/A	J100249	J100249	J100249
		EPDM	N/A	106519	N/A	N/A	N/A

### PUMP SPARE PARTS LIST

ITEM	QTY	DESCRIPTION	PART NUMBER				
			MODEL SFM	MODEL SFM-DEF	MODEL SFP	MODEL SFV	MODEL SFVV
12	1	<b>INNER TUBE (SFM/SFM-DEF/SFP/SFV = POLYPROPYLENE) (SFVV = PVDF)</b>					
		27"	108373-2	108373-2	108373-2	108373-2	108373-7
		40"	108373-3	108373-3	108373-3	108373-3	108373-8
		48"	108373-4	108373-4	108373-4	108373-4	108373-9
		54"	108373-12	108373-12	108373-12	108373-12	108373-13
		60"	108373-5	108373-5	108373-5	108373-5	108373-10
		72"	108373-6	108373-6	108373-6	108373-6	108373-11
13	1 (27"-48") 2 (60") 3 (72")	<b>CENTER SUPPORT</b>					
		POLYPROPYLENE	111206-1	111206-1	111206-1	111206-1	N/A
		ETFE	N/A	N/A	N/A	N/A	111206-2
*14	1	<b>SHAFT SLEEVE (PTFE)</b>					
		27"	108375-2	108375-2	108375-2	108375-2	108375-2
		40"	108375-3	108375-3	108375-3	108375-3	108375-3
		48"	108375-4	108375-4	108375-4	108375-4	108375-4
		54"	108375-7	108375-7	108375-7	108375-7	108375-7
		60"	108375-5	108375-5	108375-5	108375-5	108375-5
		72"	108375-6	108375-6	108375-6	108375-6	108375-6
15	1	<b>OUTER TUBE (SFM/SFM-DEF/SFP/SFV = POLYPROPYLENE) (SFVV = PVDF)</b>					
		27"	111208-1	111208-1	111208-1	111208-7	111208-13
		40"	111208-2	111208-2	111208-2	111208-8	111208-14
		48"	111208-3	111208-3	111208-3	111208-9	111208-15
		54"	111208-4	111208-4	111208-4	111208-10	111208-16
		60"	111208-5	111208-5	111208-5	111208-11	111208-17
		72"	111208-6	111208-6	111208-6	111208-12	111208-18
*16	1	<b>DIFFUSER W/ PTFE BUSHING</b>					
		POLYPROPYLENE	111209-1	111209-1	111209-1	N/A	N/A
		PVDF	N/A	N/A	N/A	111209-2	111209-2
*17	1	<b>IMPELLER - HIGH FLOW (FOR USE WITH "DIFFUSER COVER - HIGH FLOW")</b>					
		POLYPROPYLENE	111210-1	111210-1	111210-1	N/A	N/A
		ETFE	N/A	N/A	N/A	111210-2	111210-2
*18	1	<b>IMPELLER - HIGH HEAD (FOR USE WITH "DIFFUSER COVER - HIGH HEAD")</b>					
		POLYPROPYLENE	111211-1	111211-1	111211-1	N/A	N/A
		ETFE	N/A	N/A	N/A	111211-2	111211-2

## PUMP SPARE PARTS LIST

ITEM	QTY	DESCRIPTION	PART NUMBER				
			MODEL SFM	MODEL SFM-DEF	MODEL SFP	MODEL SFV	MODEL SFVV
*19	1	<b>DIFFUSER COVER - HIGH FLOW</b>					
		POLYPROPYLENE	111212-1	111212-1	111212-1	N/A	N/A
		PVDF	N/A	N/A	N/A	111212-2	111212-2
*20	1	<b>DIFFUSER COVER - HIGH HEAD</b>					
		POLYPROPYLENE	111213-1	111213-1	111213-1	N/A	N/A
		PVDF	N/A	N/A	N/A	111213-2	111213-2

\*Recommended spare parts



**FINISH THOMPSON INC.**

921 Greengarden Road • Erie, PA 16501-1591 U.S.A.  
 Ph 814-455-4478 • Fax 814-455-8518  
 Email [fti@finishthompson.com](mailto:fti@finishthompson.com) • [www.finishthompson.com](http://www.finishthompson.com)

Service 1-800-888-3743  
 P/N 111214 R2  
 09/12/2022