

BLACKMER POWER PUMPS

INSTALLATION OPERATION AND MAINTENANCE INSTRUCTIONS

MODELS: XLW2F, XLW3F, XLW4A
DISCONTINUED MODELS: XLW2E-N, XLW3E-N

963907
INSTRUCTIONS NO. 105-B00

Section	105
Effective	Jul 2018
Replaces	Jul 2015



TABLE OF CONTENTS	Page
PUMP DATA	
Technical Data	2
Initial Pump Start Up Information	2
INSTALLATION	
Pre-Installation Cleaning	3
Location and Piping	3
Mounting - Stationary	3
Mounting - Truck	3
Coupling Alignment	4
Pump Rotation	4
To Change Pump Rotation	4
Check Valves	4
OPERATION	
Pre-Start Up Check List	5
Start Up Procedures	6
Running the Pump in Reverse Rotation	6
Flushing the Pump	6
Pump Relief Valve	6
Relief Valve Setting and Adjustment	7
MAINTENANCE	
Lubrication	7
Strainers	8
Vane Replacement	8
Pump Disassembly	8
Parts Replacement	8
Pump Assembly	9
FLANGE MOUNTED GEAR REDUCER MAIN.	12
TROUBLE SHOOTING	14

NOTE:

Numbers in parentheses following individual parts indicate reference numbers on Blackmer Parts List No. 105-B01, 105-B02 and 105-B04.

Blackmer pump manuals and parts lists may be obtained from Blackmer's website (www.blackmer.com) or by contacting Blackmer Customer Service.

SAFETY DATA



This is a SAFETY ALERT SYMBOL.

When you see this symbol on the product, or in the manual, look for one of the following signal words and be alert to the potential for personal injury, death or major property damage



Warns of hazards that WILL cause serious personal injury, death or major property damage.



Warns of hazards that CAN cause serious personal injury, death or major property damage.



Warns of hazards that CAN cause personal injury or property damage.

NOTICE:

Indicates special instructions which are very important and must be followed.

NOTICE:

Blackmer Pumps **MUST** only be installed in systems, which have been designed by qualified engineering personnel. The system **MUST** conform to all applicable local and national regulations and safety standards.

This manual is intended to assist in the installation and operation of the Blackmer XLW Series pumps, and **MUST** be kept with the pump.

Pump service shall be performed by qualified technicians **ONLY**. Service shall conform to all applicable local and national regulations and safety standards.

Thoroughly review this manual, all instructions and hazard warnings, **BEFORE** performing any work on the pump.

Maintain **ALL** system and pump operation and hazard warning decals.

SAFETY DATA

⚠ WARNING



Hazardous machinery can cause serious personal injury.

Failure to disconnect and lockout electrical power or engine drive before attempting maintenance can cause severe personal injury or death

⚠ WARNING



Hazardous voltage. Can shock, burn or cause death.

Failure to disconnect and lockout electrical power before attempting maintenance can cause shock, burns or death

⚠ WARNING



Hazardous or toxic fluids can cause serious injury.

If pumping hazardous or toxic fluids, system must be flushed and decontaminated, inside and out, prior to performing service or maintenance

⚠ WARNING



Hazardous pressure can cause personal injury or property damage

Disconnecting fluid or pressure containment components during pump operation can cause serious personal injury, death or major property damage

⚠ WARNING



Do not operate without guard in place

Operation without guards in place can cause serious personal injury, major property damage, or death.

⚠ WARNING



Hazardous pressure can cause personal injury or property damage

Failure to relieve system pressure prior to performing pump service or maintenance can cause personal injury or property damage.

PUMP DATA

PUMP IDENTIFICATION

A pump Identification tag, containing the pump serial number, I.D. number, and model designation, is attached to each pump. It is recommended that the data from this tag be recorded and filed for future reference. If replacement parts are needed, or if information pertaining to the pump is required, this data must be furnished to a Blackmer representative.

TECHNICAL DATA

	XLW2 XLW3	XLW4
Maximum Pump Speed	350 RPM	350 RPM
Maximum Operating Temperature	300°F (149°C)	300°F (149°C)
Maximum Viscosity	75,000 SSU (15,750 cP)	20,000 SSU (4,250 cP)
Maximum Differential Pressure	150 psi (10.3 Bar)	150 psi (10.3 Bar)
Maximum Working Pressure	350 psi (24.1 Bar)	350 psi (24.1 Bar)

* Technical Data is for standard materials of construction. Consult Blackmer Material Specs for optional materials of construction.

INITIAL PUMP START UP INFORMATION

Model No.: _____
Serial No.: _____
ID No.: _____
Date of Installation: _____
Inlet Gauge Reading: _____
Discharge Gauge Reading: _____
Flow Rate: _____

INSTALLATION

NOTICE:

Blackmer pumps must only be installed in systems designed by qualified engineering personnel. System design must conform with all applicable regulations and codes and provide warning of all system hazards.

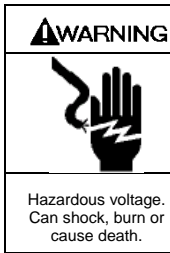

- ▲ Install, ground and wire to local and National Electrical Code requirements.
- ▲ Install an all-leg disconnect switch near the unit motor.
- ▲ Disconnect and lockout electrical power before installation or service
- ▲ Electrical supply **MUST** match motor complete specifications

▲ Motors equipped with thermal protection automatically disconnect motor electrical circuit when overload exists. Motor can start unexpectedly and without warning.

PRE-INSTALLATION CLEANING

NOTICE:

New pumps contain residual test fluid and rust inhibitor. If necessary, flush pump prior to use.

Foreign matter entering the pump WILL cause extensive damage. The supply tank and intake piping MUST be cleaned and flushed prior to pump installation and operation.

LOCATION AND PIPING

Pump life and performance can be significantly reduced when installed in an improperly designed system. Before starting the layout and installation of the piping system, review the following:

1. Locate the pump as near as possible to the source of supply to avoid excessive inlet pipe friction.
2. The inlet line **MUST** be at least as large as the intake port on the pump. It should slope downward to the pump, and should not contain any upward loops. Eliminate restrictions such as sharp bends; globe valves, unnecessary elbows, and undersized strainers.
3. It is recommended a strainer be installed in the inlet line to protect the pump from foreign matter. The strainer should be located at least 24" (0.6m) from the pump, and have a net open area of at least four times the area of the intake piping. Strainers must be cleaned regularly to avoid pump starvation.
4. The intake system must be free of air leaks.
5. Expansion joints, placed at least 36" (0.9m) from the pump, will compensate for expansion and contraction of the pipes. Contact the flexible connector/hose manufacturer for required maintenance/care and design assistance in their use.
6. Install pressure gauges in the NPT ports provided in the pump casing to check pump at start up.
7. ALL piping and fittings **MUST** be properly supported to prevent any piping loads from being placed on the pump.

8. Check alignment of pipes to pump to avoid strains which might later cause misalignment. See Figure 1. Unbolt flanges or break union joints. Pipes should not spring away or drop down. After pump has been in operation for a week or two, completely recheck alignment.

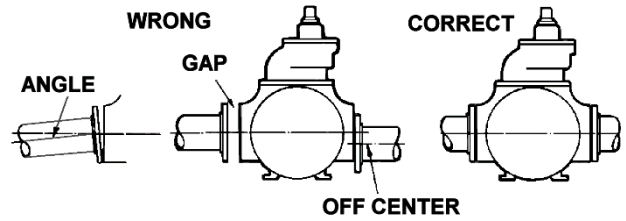

Figure 1

9. When pumping liquids at elevated temperature, provisions should be made to compensate for expansion and contraction of the pipes, especially when long pipe lines are necessary. Steel pipe expands approximately 3/4" (1.9 cm) per 100 feet (30.49 m) per 100°F (37.8°C) rise in temperature.

PUMP MOUNTING - STATIONARY

A solid foundation reduces noise and vibration, and will improve pump performance. On permanent installations it is recommended the pumping unit be secured by anchor bolts as shown in Figure 2. This arrangement allows for slight shifting of position to accommodate alignment with the mounting holes in the base plate.

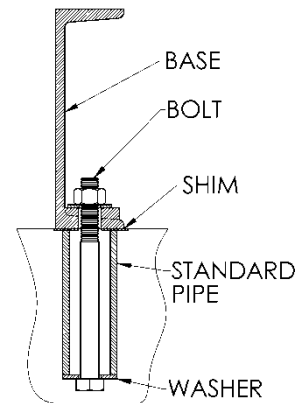

Figure 2 - Pipe Type Anchor Bolt Box

For new foundations, it is suggested that the anchor bolts be set in concrete. When pumps are to be located on existing concrete floors, holes should be drilled into the concrete to hold the anchor bolts.

When installing units built on channel or structural steel type bases, use care to avoid twisting the base out of shape when anchor bolts are tightened. Shims should be used under the edges of the base prior to tightening of the anchor bolts to prevent distortion.

PUMP MOUNTING - TRUCK

If the pump is to be mounted on a truck and driven via a PTO shaft or hydraulic motor, please refer to Blackmer Form 578..

COUPLING ALIGNMENT – LONG COUPLED

The pump must be directly coupled to a gear and/or driver with a flexible coupling. Verify coupling alignment after installation of new or rebuilt pumps. Both angular and parallel coupling alignment **MUST** be maintained between the pump, gear, motor, etc. in accordance with manufacturer's instructions. See Figure 3.

1. Parallel alignment: The use of a laser alignment tool or dial indicator is preferred. If a laser alignment tool or dial indicator is not available, use a straightedge. Turn both shafts by hand, checking the reading through one complete revolution. Maximum offset should be less than .005" (.127 mm).
2. Angular alignment: Insert a feeler gauge between the coupling halves. Check the spacing at 90° increments around the coupling (four checkpoints). Maximum variation should not exceed .005" (.127 mm). Some laser alignment tools will check angular alignment as well.
3. Replace the coupling guards after setting alignment.

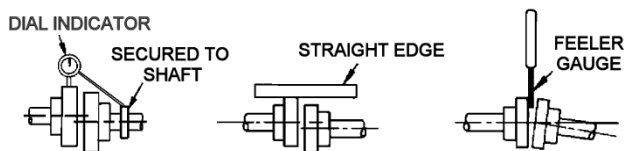

Figure 3 – Alignment Check

ALIGNMENT – FLANGE MOUNTED GEAR REDUCER

If the unit is assembled with a Blackmer Flange Mounted Gear Reducer, no coupling alignment is required. The motor, gearbox, and pump are rigidly connected with bolted, flange connections. These flanges ensure the motor shaft, gearbox shafts, and pump shaft are aligned correctly, without the need for manual alignment. However, due to variations in base and foundation geometry the unit will require shimming to reduce stress on the gearbox and pump adapter. See *PRESTART CHECKLIST* section for details.

PUMP ROTATION

A right-hand pump rotates clockwise with the intake on the right side, when viewed from the driven end.

A left-hand pump rotates counterclockwise with the intake on the left side, when viewed from the driven end.

TO REVERSE PUMP ROTATION

To reverse rotation, the pump must be disassembled then reassembled with the shaft on the opposite side of the pump. See the 'Maintenance' section for instructions.

CHECK VALVES

The use of check valves or foot valves in the supply tank is not recommended with self-priming, positive displacement pumps.

If the possibility of liquid backflow exists when the pump is off, a check valve in the pump discharge piping is recommended because the pump can motor in the reverse rotation and create undue stress on all attached components. Never start a pump when it is rotating in the reverse rotation as the added starting torque can damage the pump and related equipment.

OPERATION

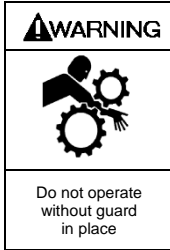

Operation without guards in place can cause serious personal injury, major property damage, or death.

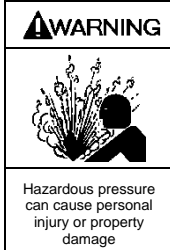

Disconnecting fluid or pressure containment components during pump operation can cause serious personal injury, death or major property damage

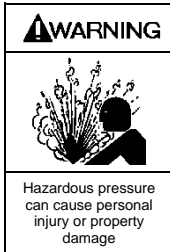

Failure to relieve system pressure prior to performing pump service or maintenance can cause personal injury or property damage.

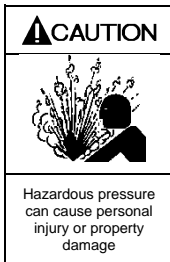

Pumps operating against a closed valve can cause system failure, personal injury and property damage

3g. The unit is properly shimmed when all 4 motor shims have the same amount of tension when pulled

3h. Bolt down the motor with the appropriate fastener.

4. Blackmer Flange Mounted Gearboxes will be shipped with Mobil SHC630 synthetic oil. If replacing the oil, refer to the **FLANGE MOUNTED GEAR REDUCER MAINTENANCE** section.
5. Blackmer helical gear reducers (if supplied) are shipped from the factory without oil in the gearcase. Fill with the grade of oil indicated on the reducer tag. For more specific instructions on Blackmer gear reducers, refer to the appropriate Gear reducer Installation, Operation and Instruction Manual.
6. Check the entire pumping system to verify that the proper inlet and discharge valves are fully open, and that the drain valves and other auxiliary valves are closed.
7. Install vacuum and pressure gauges on the pump in the 1/4" NPT connections provided to check suction and discharge conditions after pump start-up.
8. Check the wiring of the motor, and briefly turn on the power to make sure that the pump rotates in the direction of the rotation arrow.

PRE-START UP CHECK LIST

1. Check the alignment of the pipes to the pump. Pipes should be supported so that they do not spring away or drop down when pump flanges or union joints are disconnected.
2. Verify proper coupling alignment on long coupled units.
3. For units assembled with a Blackmer Flange Mounted Gearbox:
 - 3a. Bolt down the pump foot, while supporting the motor with an appropriate lifting device (e.g. crane)
 - 3b. Place a .125" thick shim under each of the motor mounting holes
 - 3c. Slowly lower the motor until it is unsupported
 - 3d. Try pulling out each of the shims, while noticing the pull tension
 - 3e. If the shims closest to the motor shaft easily pull out, increase the shim thickness the same at all locations and recheck
 - 3f. If the shims furthest from the motor shaft easily pull out, decrease the shim thickness the same at all locations and recheck

START UP PROCEDURES

NOTICE:

Consult the "General Pump Troubleshooting" section of this manual if difficulties during start up are experienced.

1. Start the motor. Priming should occur within one minute.
2. Check the suction and discharge pressure to see if the pump is operating within the expected conditions. Record pressures in the 'Initial Start Up Information' section.
3. Check for leakage from the piping and equipment.
4. Check for overheating, excessive noise or vibration of the pump, reducer, and motor.
5. Check the flow rate to ensure the pump is operating within the expected parameters. Record flow rate in the 'Initial Start Up Information' section.
6. Check the pressure setting of the relief valve by briefly closing a valve in the discharge line and reading the pressure gauge. This pressure should be 20 psi (1.4 bar) higher than the maximum operating pressure.

Do not run the pump for more than 10-15 seconds with the discharge valve completely closed.

If adjustments need to be made, refer to "Relief Valve Setting & Adjustment."

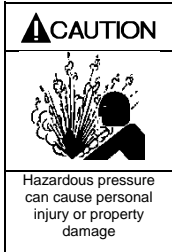

Incorrect settings of the pressure relief valve can cause pump component failure, personal injury, and property damage.

RUNNING THE PUMP IN REVERSE ROTATION

NOTICE:

Pump should be operated in reverse rotation for no more than 10 minutes and only when a separate pressure relief valve is installed to protect the pump from excessive pressure.

It may be desirable to run the pump in reverse rotation for system maintenance. The pump will operate satisfactorily in reverse rotation for a LIMITED time, **at a reduced performance level.**

FLUSHING THE PUMP

NOTICE:

If flushing fluid is to be left in the pump for an extended time, it must be a lubricating, non-corrosive fluid. If a corrosive or non-lubricating fluid is used, it must be flushed from the pump immediately.

1. To flush the pump, run the pump with the discharge valve open and the intake valve closed. Bleed air into the pump through the intake gauge plug hole or through a larger auxiliary fitting in the intake piping. Pump air for 30 second intervals to clean out most of the pumpage.
2. Run a system compatible flushing fluid through the pump for one minute to clear out the remainder of the original pumpage. The valve in the discharge line should be restricted to build up 10 psi (0.7 bar) to force flushing liquid through the bearing seal chamber.
3. To remove the flushing fluid, follow step 1 above.

NOTICE:

After flushing the pump some residual fluid will remain in the pump and piping.

NOTICE:

Properly dispose of all waste fluids in accordance with the appropriate codes and regulations.

PUMP RELIEF VALVE

NOTICE:

The pump internal relief valve is designed to protect the pump from excessive pressure and must not be used as a system pressure control valve.

XLW series pumps are fitted with an internal pressure relief valve that bypasses back to the suction side of the pump.

Pumping volatile liquids under suction lift may cause cavitation. Partial closing of the discharge valve WILL result in internal relief valve chatter and is NOT recommended. For these applications, install an external system pressure control valve, and any necessary bypass piping, back to the storage tank.

A system pressure control valve is also recommended when operating for extended periods (more than 15 seconds) against a closed discharge valve.

RELIEF VALVE SETTING AND ADJUSTMENT

The relief valve pressure setting is marked on a metal tag attached to the valve cover. Generally, the relief valve should be set at least 15 - 20 psi (1.0 - 1.4 Bar) higher than the operating pressure, or the external bypass valve setting (if equipped).

DO NOT remove the R /V Cap OR adjust the relief valve pressure setting while the pump is in operation.

1. To **INCREASE** the pressure setting, remove the relief valve cap, loosen the locknut, and turn the adjusting screw *inward*, or clockwise. Replace the valve cap.
2. To **DECREASE** the pressure setting, remove the relief valve cap, loosen the locknut, and turn the adjusting screw *outward*, or counterclockwise. Replace the valve cap.

Refer to the individual Blackmer pump parts lists for various spring pressure ranges. Unless specified otherwise, pumps are supplied from the factory with the relief valve adjusted to the mid-point of the spring range.

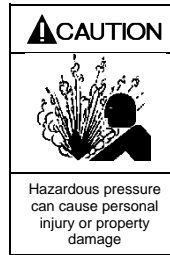

Incorrect settings of the pressure relief valve can cause pump component failure, personal injury, and property damage.

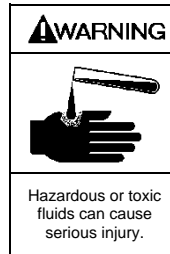

Relief valve cap is exposed to pumpage and will contain some fluid

MAINTENANCE:

NOTICE:

Maintenance shall be performed by qualified technicians only, following the appropriate procedures and warnings as presented in this manual.

SCHEDULED MAINTENANCE

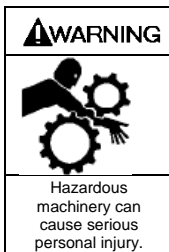

Failure to disconnect and lockout electrical power or engine drive before attempting maintenance can cause severe personal injury or death

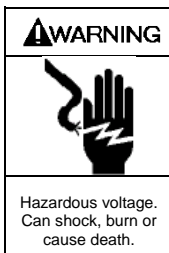

Failure to disconnect and lockout electrical power before attempting maintenance can cause shock, burns or death

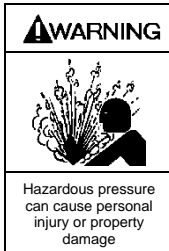

Failure to relieve system pressure prior to performing pump service or maintenance can cause personal injury or property damage.



Disconnecting fluid or pressure containment components during pump operation can cause serious personal injury, death or major property damage

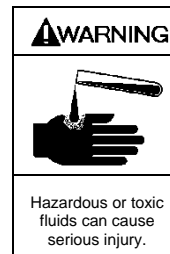

If pumping hazardous or toxic fluids, system must be flushed and decontaminated, inside and out, prior to performing service or maintenance

LUBRICATION

NOTICE:

To avoid possible entanglement in moving parts do not lubricate pump bearings, gear reducer or any other parts while the pump is running.

NOTICE:

If pumps are repainted in the field, ensure that the grease relief fittings (76A) are functioning properly after painting. Do NOT paint them closed. Remove any excess paint from the fittings.

Pump bearings should be lubricated every one to twelve weeks (AT MINIMUM), depending on the application, and operating conditions.

Recommended Grease:

Mobil® - Mobilgrease XHP222, or equivalent.

Greasing Procedure:

1. Remove the grease relief fittings (76A) from the bearing covers (27A).
2. **SLOWLY** apply grease with a hand gun until grease begins to escape from the grease relief fitting port.
3. Replace the grease relief fittings (76A).

DO NOT overgrease pump bearings. While it is normal for some grease to escape from the grease tell-tale hole after lubrication, excessive grease on pumps equipped with mechanical seals can cause seal failure.

If equipped: Blackmer gear reducers are shipped from the factory without oil in the gearcase. Fill with the grade of oil indicated on the reducer tag. The oil should be changed after the first 48 hours of use and approximately every 500 hours of use thereafter.

STRAINERS

Strainers must be cleaned regularly to avoid pump starvation. Schedule will depend upon the application and conditions.

VANE REPLACEMENT

NOTICE:

Maintenance shall be performed by qualified technicians only, following the appropriate procedures and warnings as presented in manual.

1. Flush the pump per instructions in this manual. Drain and relieve pressure from the pump and system as required.
2. Remove the head assembly from the **outboard** (non-driven) side of the pump according to steps 4 - 8 in the "Pump Disassembly" section of this manual.
3. Turn the shaft by hand until a vane comes to the top (12 o'clock) position of the rotor. Remove the vane.
4. Install a new vane, ensuring that the rounded edge is UP, and the relief grooves are facing towards the direction of rotation. See Figure 4.
5. Repeat steps 3 and 4 until all vanes have been replaced. This method of vane installation ensures the push rods do not fall out of their rotor slots.
6. Reassemble the pump according to the "Pump Assembly." section of this manual.

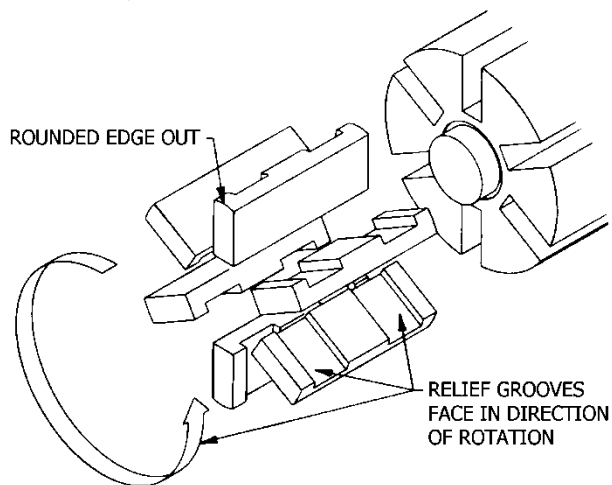

Figure 4 – Vane Replacement

PUMP DISASSEMBLY

NOTICE:

Follow all hazard warnings and instructions provided in the "maintenance" section of this manual.

NOTE: The numbers in parentheses following individual parts indicate reference numbers on the Pump Parts List.

1. Flush the pump per instructions in this manual. Drain and relieve pressure from the pump and system as required.
2. Starting on the **inboard** (driven) end of the pump, clean the pump shaft thoroughly, making sure the shaft is free of nicks and burrs. This will prevent damage to the mechanical seal when the inboard head assembly is removed.

3. Remove the inboard bearing cover capscrews (28) and slide the inboard bearing cover (27A) and gasket (26) off the shaft. Discard the bearing cover gasket. On 2-inch pump models, the dirt shield will slide off with the bearing cover.
4. Remove the outboard bearing cover capscrews (28) and slide the outboard bearing cover (27) and gasket (26) off the shaft. Discard the bearing cover gasket.
5. To remove locknuts and lockwashers (24A and 24B):
 - a. Bend up the engaged lockwasher tang and rotate the locknut counterclockwise to remove it from the shaft.
 - b. Slide the lockwasher off the shaft. Inspect the lockwasher for damage and replace as required.
 - c. Repeat steps a and b on the opposite shaft end.
6. Remove the head capscrews (21). Gently pry the head away from the casing using two large screwdrivers. The head O-ring should come off with the head assembly.
7. Slide the head and O-ring off the shaft. The bearing (24), mechanical seal stationary seat and stationary O-ring (153A & 153D) will come off with the head assembly.
 - a. On 4-inch models, remove the disc from the head by removing the disc machine screws (71A) and lockwashers (71B). The mechanical seal rotating assembly (153B, 153C, 153E) will be released when the disc is removed.
 - b. Pull the bearing (24) from the housing in the head.
 - c. To remove the mechanical seal stationary seat (153A), use the blunt end of a screw driver to gently push the backside of the stationary seat from the head. Place a cloth under the seal to avoid damage. Be careful not to contact the polished face of the seal during removal. Remove and discard mechanical seal stationary O-ring.
8. On 2 and 3-inch models, carefully pull the rotating seal assembly, including seal jacket (153C), rotating seal face and rotating O-ring (153B & 153E) from the shaft. Remove and discard the rotating O-ring. Remove the disc (71).
9. Pull the rotor and shaft (13) from the casing. While one hand is pulling the shaft, the other hand should be cupped underneath the rotor to prevent the vanes (14) and pushrods (77) from falling out. Carefully set the rotor and shaft aside for future vane replacement and reassembly.
10. Lay the pump flat with the remaining head facing upward to remove the outboard head assembly, mechanical seal and disc from the outboard side of the pump, as instructed in steps 6 - 8.
11. If necessary, remove the liner (41) by tapping around the outside diameter of the liner with a hard wood drift and a hammer until it is driven from the casing.

PARTS REPLACEMENT

1. If any of the O-rings have been removed or disturbed during disassembly, they be replaced with new O-rings.
NOTE: PTFE O-rings should be heated in hot water to aid installation.
2. Excessive or continuous leakage from the tell-tale hole in the bearing cover may be an indication of a damaged mechanical seal. If a mechanical seal has been leaking, it is recommended the entire seal be replaced. Refer to "General Pump Troubleshooting" for possible causes of seal leakage.

PUMP ASSEMBLY

Before reassembling the pump, inspect all component parts for wear or damage, and replace as required. Wash out the bearing/seal recess of the head and remove any burrs or nicks from the rotor and shaft.

Reassemble the OUTBOARD side of the pump first:

For a CLOCKWISE rotation pump, position the pump cylinder with the INTAKE port to the **left**.

For a COUNTERCLOCKWISE rotation pump, position the pump cylinder with the INTAKE port to the **right**.

1. Install the liner key (74) in the slot located in the top of the liner. Align the key with the notch in the top of the pump casing and start the liner into the casing.

The word "INTAKE" cast on the liner must face the intake port of the pump casing. Uniformly tap the outer edge of the liner with a rubber mallet to fully insert into the casing.

2. On 2 and 3-inch models, place the disc (71) against the liner with the seal cavity outward.
3. On 4-inch models, attach the disc to the outboard head without the mechanical seal components. Install disc machine screws (71A) and lockwashers (71B)
4. Without installing the head O-ring or mechanical seal components, temporarily attach the outboard head and bearing to the casing. Install and hand-tighten two head capscrews, 180 degrees apart. This head will be used to hold and align the rotor and shaft while the inboard side of the pump is assembled.
5. Turn the pump around to begin assembly on the inboard side. Before installing the rotor & shaft assembly, the direction of pump rotation must be determined as indicated under the "Pump Rotation" section of this manual.

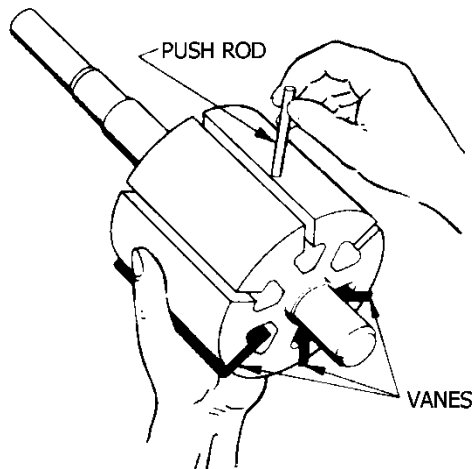

Figure 5 – Pushrod Installation

6. Remove the vanes (14) and push rods (77) from the rotor and shaft assembly. Inspect for wear and damage, and replace as follows:
 - a. Insert the vanes into the bottom three rotor slots with the relief grooves facing in the direction of pump rotation, and with the rounded edges outward. See Figure 4.
 - b. Hold the three bottom vanes in place while inserting the three push rods (77). See Figure 5.
 - c. After the bottom vanes and push rods are installed, carefully insert the non-driven end of rotor and shaft into the casing.

- d. Install the remaining vanes into the top positions of the rotor.

7. DISC – 2 and 3-inch Models

Install the disc (71) on the inboard side of the pump with the seal cavity facing outward and the disc relief hole located as shown in Figure 6.

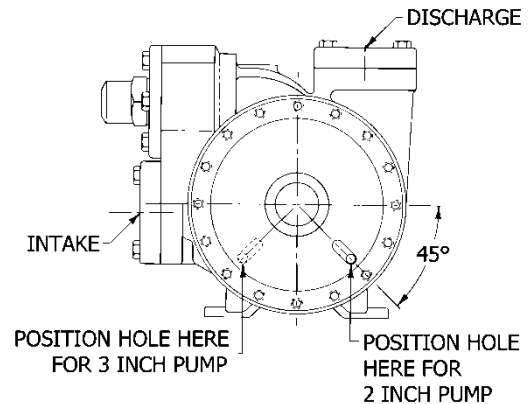

Figure 6 – Disc Relief Hole Location
2 and 3-inch Models

8. MECHANICAL SEAL – 2 and 3-inch Models

Rotating Assembly

- a. Apply a small amount of motor oil on the shaft between the shaft threads and the rotor.
- b. Slide the seal jacket assembly (153C) over the shaft and into the disc cavity with the drive tangs of the jacket towards the rotor. Rotate the jacket assembly to engage the drive tangs in the rotor slots.
- c. Install a new rotating O-ring (153E) in the rotating seal face (153B). Align and insert the rotating assembly into the the seal jacket with the polished face outward. Clean the polished face with a clean tissue and alcohol.

Stationary Seat

- a. Apply a small amount of motor oil in the seal access of the head.
- b. Install a new stationary O-ring (153D) in the stationary seat (153A). Clean the polished face with a clean tissue and alcohol. Align the pin in the stationary seat with the slot in the head recess and push the seat fully into the seal recess with the polished face outward.

9. DISC and MECHANICAL SEAL – 4-inch Models

- a. Before attaching the disc, apply a small amount of motor oil in the recess of the head.
- b. Install a new stationary O-ring (153D) in the stationary seat (153A). Align the pin in the stationary seat with the slot in the head recess and push the seat fully into the seal recess with the polished face outward. Clean the polished face with a clean tissue and alcohol.
- c. Install a new rotating O-ring (153E) in the rotating seal face (153B). Clean the polished face with a clean tissue and alcohol. Place the polished face of the rotating seal against the face of the stationary seat in the head.
- d. Align and install the seal jacket assembly (153C) over the rotating face with the drive tangs outward.
- e. Carefully place the disc on the head with the seal cavity inward. The drive tangs of the seal jacket should protrude through the center hole of the disc.

- f. Position the disc relief hole so that when the head is mounted on the pump with the "Blackmer" name in an upright position, the disc hole will be towards the INTAKE side of the pump. See Figure 7.
- g. Install the disc machine screws (71A) and lockwashers (71B).

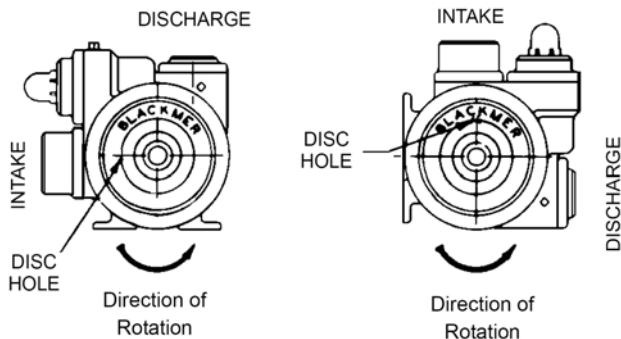

Figure 7 – Disc Relief Hole Location (4-inch Models)

10. Install a new head O-ring (72) in the groove on the inside face of the head. Lay the O-ring flat and start in on one side of the groove, stretching ahead with the fingers, as shown in Figure 7.

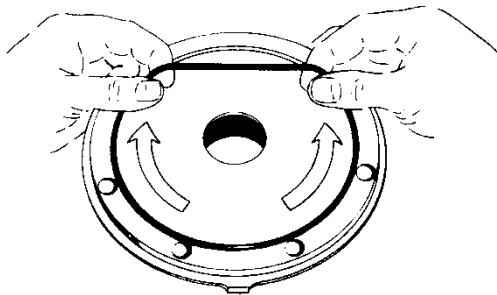

Figure 7 – Head O-Ring Installation

11. Carefully install the head assembly (20) over the shaft. Do not contact the end of the shaft with the mechanical seal. Position the head with the small weep hole towards the bottom of the pump. Install and partially tighten four head capscrews (21) 90° apart. The remaining capscrews will be installed in step 18.
- On 4-inch models, make sure the head is mounted with the "Blackmer" name upright and the disc relief hole towards the intake side of the pump. The seal jacket drive tangs must be engaged in the rotor slots.
12. Hand pack the ball bearing (24) with grease. Refer to the "Lubrication" section for the recommended grease.
13. Install the bearing into the head recess. The bearing balls should face outward, with the grease shield (ref. 123, 2" models only) inward. The bearing must be fully and squarely seated in the head.
14. Turn the pump casing around and remove the outboard head and disc previously installed.
15. Install the mechanical seal and disc in the outboard head as instructed in steps 7 through 8 for the 2 and 3-inch models or step 9 for the 4-inch models.
16. Finish assembling the outboard side of the pump as instructed in steps 10 through 13.
17. Rotate the shaft by hand to engage the mechanical seal drive tangs, and to test for binding or tight spots. If the rotor does not turn freely, lightly tap the rims of the heads with a soft faced mallet until the correct position is found.
18. Install and partially tighten the remaining head capscrews

19. Uniformly torque the head capscrews to 30 lbs ft (40.7 Nm), alternating between one side of the head and the other. Frequently check that the shaft still turns freely. If tight, loosen the capscrews and repeat the procedure. If the shaft continues to bind, check for grease or dirt on the mechanical seal faces.

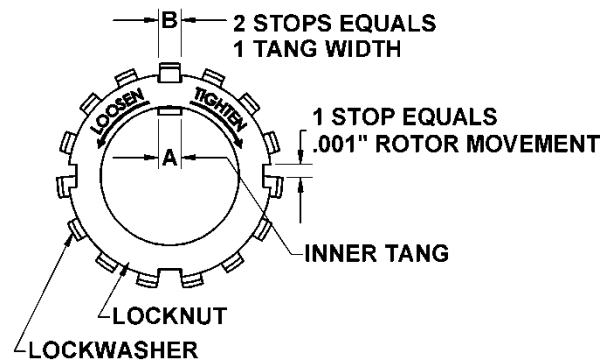

Figure 8 – Locknut Assembly

20. LOCKNUT ADJUSTMENT

It is important that the bearing locknuts (24A) and lockwashers (24B) be installed and adjusted properly. Overtightening locknuts can cause bearing failure or a broken lockwasher tang. Loose locknuts will allow the rotor to shift against the discs, causing wear. See Fig. 8.

- a. On both ends of the pump shaft, install a lockwasher (24B) with the tangs facing outward, followed by a locknut (24A) with the tapered end inward. Ensure the inner tang "A" of the lockwasher is located in the slot in the shaft threads, bending it slightly, if necessary.
- b. Tighten both locknuts to ensure that the bearings are bottomed in the head recess. DO NOT overtighten and bend or shear the lockwasher inner tang.
- c. Loosen both locknuts one complete turn.
- d. Tighten one locknut until a slight rotor drag is felt when turning the shaft by hand.
- e. Back off the nut the width of one lockwasher tang "B". Secure the nut by bending the closest aligned lockwasher tang into the slot in the locknut. The pump should turn freely when rotated by hand.
- f. Tighten the opposite locknut by hand until it is snug against the bearing. Then, using a spanner wrench, tighten the nut the width of one lockwasher tang "B". Tighten just past the desired tang, then back off the nut to align the tang with the locknut slot. Secure the nut by bending the aligned lockwasher tang into the slot in the locknut. The pump should continue to turn freely when rotated by hand.
- g. To check adjustment, grasp the nut and washer with fingers and rotate back and forth. If this cannot be done, one or both locknuts are too tight and should be alternately loosened one stop at a time 0.001" (0.025mm). Begin by loosening the locknut adjusted last.
21. Inspect the grease seal (104) for wear or damage and replace as required. Grease the outside diameter of the grease seal and push it into the inboard bearing cover (27A) with the lip of the seal inward (towards the pump).
22. Attach a new bearing cover gasket (26) and the inboard bearing cover (27A) to the inboard head. Install the outboard bearing cover (27) and a new gasket to the outboard head. Make sure the grease fittings (76) on the bearing covers are accessible. Install and torque the bearing cover capscrews (28) to 30 lbs ft (40.7 Nm).

23. RELIEF VALVE ASSEMBLY

- a. Insert the valve (9) into the relief valve bore of the casing with the fluted end inward.
- b. Install the relief valve spring (8) and spring guide (7) against the valve.
- c. Attach a new relief valve O-ring (10) and the valve cover (4) on the cylinder.
- d. Screw the relief valve adjusting screw (2) with locknut (3) into the valve cover (4) until it makes contact with the spring guide (7).
- e. After the relief valve has been adjusted, tighten the Locknut (3) and install the relief valve cap (1) and O-ring (88)

NOTICE:

The relief valve setting MUST be tested and adjusted more precisely before putting the pump into service. Refer to "Relief Valve Setting and Adjustment"

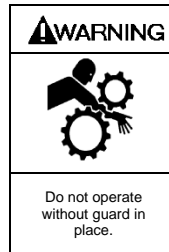

Operation without guards in place can cause serious personal injury, major property damage, or death.

24. Reinstall coupling, shaft key, and coupling guards.
25. Refer to "Pre-Start Up Check List" and "Start Up Procedures" sections of this manual prior to restarting pump operation.

FLANGE MOUNTED GEAR REDUCER MAINTENANCE

NOTICE:

Detailed maintenance instructions for the gearbox can be found at www.nord.com/docs. The following are excerpts from those documents and should be treated as reference only.

STORAGE

NOTICE:

For storage periods longer than 9 months, or for storage in less than desirable conditions, please consult NORD for recommendations.

- Storage for up to 9 months is possible, so long as the following conditions are observed:
- Store the gear unit in its actual mounting position in accordance with the specified oil fill-level, in a clean and dry temperature controlled area. Avoid temperature fluctuations within the range of 0°C and 40°C (32°F to 104°F) and avoid relative humidity conditions in excess of 60%.
- Protect all exposed or unpainted shaft and flange surfaces with an anti-corrosion agent or grease.
- Store in a location free from shock and vibration, to avoid false brinelling of bearing elements and raceways.
- Whenever possible, rotate the shafts periodically, by hand if necessary, to help prevent brinelling (bearing damage) and to help keep the shaft seals pliable.
- Avoid direct exposure to the sun or UV light and aggressive or corrosive materials in the environment (ozone, gases, solvents, acids, caustic solutions, salts, radioactivity, etc).

Commissioning

Prior to gear unit start-up, complete the following:

- Please check your gear unit for a vent and if applicable to your product, remove the sealing plug to activate

NOTICE:

To prevent build-up of excessive pressure, sealed vents must be activated as shown prior to gear unit start up. Excessive pressure may cause damage to internal gearbox components and leakage.

- Check the lubricant and be sure the gear unit is filled with the proper oil type, to the proper level, as determined by the mounting position.
- Check the condition of all shaft seals and all assembled flange gasket areas. If any change is detected in the shape, color, hardness or permeability, or if any leaks are detected, the corresponding shaft seals and/or gaskets must be replaced.
- Remove all anti-corrosive metal protectant from otherwise bare metal surfaces. Follow product manufacturer's directions and warnings during surface protection removal.

- Check the resistance of all motor and brake windings to verify the integrity of the winding insulation and inspect all terminal box openings and wire connection areas to verify that all components are dry and free of corrosion.

Long Term Storage

By taking special precautions, problems such as seal leakage and reducer failure due to the lack of lubrication, improper lubrication quantity, or contamination can be avoided. The following precautions will protect gear reducers during periods of extended storage:

- Store the gear unit in its actual mounting position in accordance with the specified oil fill-level, in a clean and dry temperature controlled area. Avoid temperature fluctuations within the range of 0°C and 40°C (32°F to 104°F) and avoid relative humidity conditions in excess of 60%.
- Fill the reducer full with oil that is compatible with the product normally used or recommended during service.
- Apply grease to all unpainted or unprotected shafts, bores, keyways, flange surfaces, tapped holes, and to the exterior of all oil seals.
- Store in a location free from shock and vibration, to avoid false brinelling of bearing elements and raceways.
- Once every few months rotate the input shaft approximately 10-20 revolutions to redistribute the weight of gears and shafts and to prevent brinelling of the bearings and drying of the seal track.
- Avoid direct exposure to the sun or UV light and aggressive or corrosive materials in the environment (ozone, gases, solvents, acids, caustic solutions, salts, radioactivity, etc.)

Commissioning After Long-Term Storage

- Please check your gear unit for a vent and if applicable to your product, remove the sealing plug to activate.

NOTICE:

To prevent build-up of excessive pressure, sealed vents must be activated as shown prior to gear unit start up. Excessive pressure may cause damage to internal gearbox components and leakage.

- Remove all anti-corrosive metal protectant from otherwise bare metal surfaces. Follow product manufacturer's directions and warnings during surface protection removal.
- Drain the reducer and refill it with the proper type and amount of lubricant.
- Observe start-up and initial operation to make sure there are no seal or gasket leaks, or unusual sounds, vibration or heat rise during operation.
- Check the resistance of all motor and brake windings to verify the integrity of the winding insulation and inspect all terminal box openings and wire connection areas to verify that all components are dry and free of corrosion.

Lubrication

Proper gearbox lubrication is essential in order to reduce friction, heat, and component wear. Lubricants reduce heat and wear by inserting a protective “fluid boundary” between mating parts and preventing direct metal to metal contact. Lubricants also help prevent corrosion and oxidation, minimize foam, improve heat transfer, optimize reducer efficiency, absorb shock loads and reduce noise. Most NORD reducers are shipped from the factory with a pre-determined oil fill level in accordance to the specified reducer size and mounting position.

The standard orientation for the gearbox is shown in Figure 9. The gearbox is filled with the correct amount of oil and is the correct configuration for this orientation. For any other orientation, please consult the factory.

Lubrication Table

ISO Viscosity	Oil Type	Ambient Temp Range (°F)	Brand
VG220	PAO	-31 to 140	Mobil SHC630*
VG220	MIN-EP	32 to 104	Mobilgear 600XP220
VG220	FG	23 to 104	Fuchs FM220
VG460	PAO	-31 to 176	Mobil SHC 634

*Standard Oil Shipped with Gearbox

Oil Formulation Codes:

MIN-EP - Mineral Oil with EP Additive

PAO - Synthetic Polyalphaolefin Oil

FG - Food-Grade Oil

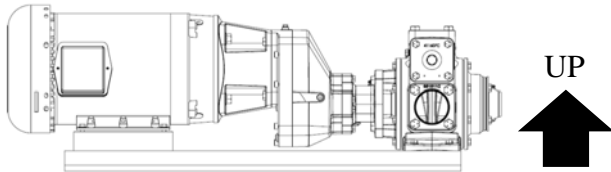

Figure 9 – Standard Gear Reducer Orientation

NOTICE:

The “Ambient Temperature” is intended to be an operation guideline based upon the typical properties of all the lubricant. The viscosity and other properties of the lubricant change based upon load, speed, ambient conditions, and reducer operating temperatures. The user should consult with their lubrication supplier & NORD gear before considering changes in oil type or viscosity.

- To prevent reducer overheating, observe the maximum operating oil temperature limits:
Mineral Oil: 176 – 180 °F
Synthetic Oil: 225 °F
- In the following instances, please consult NORD for specific recommendations:
 - Gear units will operate in high ambient temperature conditions exceeding 40 oC (104 oF).
 - Gear units will operate in cold ambient temperature conditions approaching 0 oC (32 oF) or lower.
 - Lower than an ISO VG100 viscosity oil is being considered for a cold-temperature service.
 - Fluid grease is required for lubricating the gear unit.
- Observe the general lubrication guidelines outlined in user manual U10750.

NOTICE:

Do not to mix different oils with different additive packages or different base oil formulation types. Polyglycol (PG) oils are not miscible with other oil types and should never be mixed with mineral oil or polyalphaolefin (PAO) synthetic oil.

PUMP TROUBLESHOOTING

NOTICE:

Maintenance shall be performed by qualified technicians only, following the appropriate procedures and warnings as presented in this manual.

LEAKAGE

Location

Between the head & casing

Around the shaft

Probable Cause/Corrective Action

Damaged head O-ring: Inspect and replace if necessary.

Burrs/dirt in head O-ring groove or cylinder: File and clean as necessary.

New Mechanical Seals: New seals may leak slightly at start up, but should seal up shortly thereafter.

Damaged mechanical seals: Check for damaged O-rings or cracked, scratched or worn seal faces

SHAFT BINDING

Probable Cause

Burrs, dirt or foreign particles on the heads or discs.

Improper locknut adjustment.

Contaminated mechanical seal faces.

Corrective Action

During assembly, both heads and discs must be clean and smooth. File any burrs or rough spots, and wipe the discs with a clean cloth and alcohol to remove any dirt or foreign particles.

Locknuts must be adjusted properly to center the rotor and shaft between the heads. Refer to "Locknut Installation" on Page 10.

Any trace of grease or dirt on the seal faces will prevent the faces from mating properly, causing the rotor and shaft to bind or turn hard. Use a tissue paper & alcohol to clean the seal faces. NOTE: Apply a light oil or suitable lubricant to bronze seal faces only.

OTHER POSSIBLE CAUSES OF SHAFT BINDING:

- Foreign particles on rotor, liner or vanes.
- Damaged vanes or rotor.

- Bent push rods.
 - Liquids that "set up" when inactive.
-

OVERHEATING

Probable Cause

Continual, full bypassing of the liquid.

Corrective Action

The relief valve should be adjusted such that the pump will not bypass during normal operation. **WARNING: Internal bypassing of liquid elevates the liquid temperature. The internal bypass valve should only be used for brief periods and at differential pressures below 125 psi.**

For extended periods of higher pressures, the internal bypass port must be plugged and the liquid returned back to the source.

OTHER POSSIBLE CAUSES OF OVERHEATING:

- Improper relief valve adjustment (See "Relief Valve" on Page 3).

- Plugged discharge line.
 - Closed valve.
-

PUMP TROUBLESHOOTING

LOW DELIVERY RATE

Probable Cause

Relief valve setting too low, causing the liquid to bypass.

Corrective Action

The relief valve setting should be 20 psi (1.4 bar) higher than the differential pressure.

OTHER POSSIBLE CAUSES OF A LOW DELIVERY RATE:

- Restriction in the suction line.
- Suction valve not fully open.
- Resistance in the discharge line.
- Air leaks in the suction line.
- Damaged or worn pump parts.
- Pump speed too low or too high.

Check pipe joints for leakage of air. Sometimes when recirculating liquid in a tank, the returning liquid falling through the air carries air down into the tank, which eventually gets back into the pump.

- Relief valve leaking.
- Relief valve sticking open, or not properly seating.
- Dirty strainer.
- Liner installed backwards
- Vanes install incorrectly
- Excessive restriction in discharge line causing RV to open.

EXCESSIVE NOISE AND VIBRATION

Probable Cause

Cavitation or vaporization of the liquid resulting from excessive vacuum on the pump due to starved suction.

Corrective Action

Check for:

- Inlet piping too long or too small in diameter.
- Strainer plugged or dirty.
- Undersized or restrictive fittings, such as globe valves or partially closed valves.
- Excessive amount of elbows.
- Suction lift too great.
- Pump speed too high for the viscosity of the liquid being pumped.

Entrained air or vapors in the pump.

Check pipe joints for leakage of air. Sometimes when recirculating liquid in a tank, the returning liquid falling through the air carries air down into the tank, which eventually gets back into the pump.

Pump speeds exceed the recommended maximum.

Check the recommended RPM for your specific application.

Liner Installed Backwards

The word "INTAKE", which is cast on the liner MUST be towards the intake side of the pump

Continual or long term bypassing of liquid through relief valve.

Check for restriction in the discharge line, or an improper relief valve adjustment (See "Relief Valve" on Page 6).

OTHER POSSIBLE CAUSES OF NOISE AND VIBRATION:

- Excessively worn vanes, discs or rotor.
- Bearing Worn or Damaged.
- Loose or improperly installed piping.

- Misalignment of pump and driver or bent shaft.
- Pump base not properly mounted.
- Insufficient Oil in the Gear Reducer

POOR OR NO PRIMING

Probable Cause

- Air leaks in the suction line.
- Valve partially closed or other restriction in the suction line.
- Damaged or worn pump parts.
- Too much lift for the vapor pressure of the fluid.
- A dirty or clogged strainer.

- Worn vanes.
 - Suction Valve Closed.
 - Incorrect pump rotation
 - Relief Valve partially open, valve not seating properly.
 - Pump speed too low for priming
-

PUMP TROUBLESHOOTING

DAMAGED VANES

Probable Cause

- Foreign objects entering the pump.
- Running the pump dry for extended periods of time.
- Cavitation.
- Viscosity too high for the vanes and /or the pump speed.
- Incompatibility with the liquids pumped.
- Excessive heat.
- Worn or bent push rods, or worn push rod holes.
- Settled or solidified material in the pump at start-up.
- Hydraulic hammer - pressure spikes.
- Vanes installed incorrectly (see "Vane Replacement").

BROKEN SHAFT

Probable Cause

- Foreign objects entering the pump.
- Viscosity too high for the pump speed.
- Relief valve not opening.
- Hydraulic hammer - pressure spikes.
- Pump/driver, driveline/drive shaft misalignment.
- Excessively worn vanes or vane slots.
- Settled or solidified material in the pump at start-up.
- Overtightened V-belts, if used.

SEAL LEAKAGE

Probable Cause

- O-rings not compatible with the liquids pumped.
- O-rings nicked, cut or twisted.
- Shaft at seal area damaged, worn or dirty.
- Excessive cavitation.
- Mechanical seal faces cracked, scratched, pitted or dirty.
- Ball bearings overgreased.

MOTOR OVERLOAD

Probable Cause

- Horsepower of motor not sufficient for application
- Improper wire size / wiring and/or voltage to motor.
- Misalignment in pump drive system.
- Bearing locknuts adjusted improperly.
- Excessive viscosity, pressure or speed.
- Faulty or worn bearings.
- Rotor rubbing against head or liner.
- Dirty mechanical seal faces.

The logo for Blackmer, featuring the word "Blackmer" in a large, stylized, cursive script font. A registered trademark symbol (®) is located at the bottom right of the logo.

1809 Century Avenue, Grand Rapids, Michigan 49503-1530 U.S.A.
Telephone: (616) 241-1611 • Fax: (616) 241-3752
E-mail: blackmer@blackmer.com • Internet Address: www.blackmer.com