

# BLACKMER POWER PUMPS

961224  
INSTRUCTIONS NO. 101-C00

## INSTALLATION OPERATION AND MAINTENANCE INSTRUCTIONS MODELS: GNX(H)2A, GNX(H)2.5A, GNX(H)3A, GNX(H)4A

Section 101  
Effective June 2023  
Replaces Sept 2018



TABLE OF CONTENTS	Page
<b>PUMP DATA</b>	
Technical Data .....	2
Initial Pump Start Up Information .....	2
<b>INSTALLATION</b>	
Pre-Installation Cleaning .....	3
Location and Piping.....	3
Mounting .....	3
Coupling Alignment.....	4
Motor Coupling Installation.....	4
Gear Reducer Alignment – GNX(H) Models .....	4
Pump Rotation .....	7
To Change Pump Rotation.....	7
Check Valves .....	7
<b>OPERATION</b>	
Pre-Start Up Check List .....	8
Start Up Procedures.....	9
Running the Pump in Reverse Rotation .....	10
Flushing the Pump .....	10
Pump Relief Valve.....	10
Relief Valve Setting and Adjustment.....	10
<b>PUMP MAINTENANCE</b>	
Lubrication .....	11
Strainers.....	11
Vane Replacement .....	12
Pump Disassembly .....	12
Parts Replacement .....	12
Pump Assembly.....	13
<b>GEAR REDUCER MAINTENANCE</b> .....	15
<b>PUMP TROUBLE SHOOTING</b> .....	17
<b>GEAR REDUCER TROUBLE SHOOTING</b> .....	18

**NOTE:** Numbers in parentheses following individual parts indicate reference numbers on Blackmer Parts Lists.

Blackmer pump manuals and parts lists may be obtained from Blackmer's website ([www.blackmer.com](http://www.blackmer.com)) or by contacting Blackmer Customer Service.

PUMP MODEL	PUMP PARTS LIST			
	2"	2.5"	3"	4"
GNX(H)	101-C01	101-C02	101-C03	101-C04

### SAFETY DATA



**This is a SAFETY ALERT SYMBOL.**

When you see this symbol on the product, or in the manual, look for one of the following signal words and be alert to the potential for personal injury, death or major property damage



Warns of hazards that **WILL** cause serious personal injury, death or major property damage.



Warns of hazards that **CAN** cause serious personal injury, death or major property damage.



Warns of hazards that **CAN** cause personal injury or property damage.

**NOTICE:**

Indicates special instructions which are very important and must be followed.

**NOTICE:**

Blackmer Pumps **MUST** only be installed in systems, which have been designed by qualified engineering personnel. The system **MUST** conform to all applicable local and national regulations and safety standards.

This manual is intended to assist in the installation and operation of the Blackmer power pumps, and **MUST** be kept with the pump.

Pump service shall be performed by qualified technicians **ONLY**. Service shall conform to all applicable local and national regulations and safety standards.

Thoroughly review this manual, all instructions and hazard warnings, **BEFORE** performing any work on the pump.

Maintain **ALL** system and pump operation and hazard warning decals.

## SAFETY DATA

**⚠ WARNING**



Hazardous machinery can cause serious personal injury.

Failure to disconnect and lockout electrical power or engine drive before attempting maintenance can cause severe personal injury or death

**⚠ WARNING**



Hazardous voltage. Can shock, burn or cause death.

Failure to disconnect and lockout electrical power before attempting maintenance can cause shock, burns or death

**⚠ WARNING**



Hazardous or toxic fluids can cause serious injury.

If pumping hazardous or toxic fluids, system must be flushed and decontaminated, inside and out, prior to performing service or maintenance

**⚠ WARNING**



Hazardous pressure can cause personal injury or property damage

Disconnecting fluid or pressure containment components during pump operation can cause serious personal injury, death or major property damage

**⚠ WARNING**



Do not operate without guard in place

Operation without guards in place can cause serious personal injury, major property damage, or death.

**⚠ WARNING**



Hazardous pressure can cause personal injury or property damage

Failure to relieve system pressure prior to performing pump service or maintenance can cause personal injury or property damage.

## PUMP DATA

### PUMP IDENTIFICATION

A pump Identification tag, containing the pump serial number, I.D. number, and model designation, is attached to each pump. It is recommended that the data from this tag be recorded and filed for future reference. If replacement parts are needed, or if information pertaining to the pump is required, this data must be furnished to a Blackmer representative.

#### TECHNICAL DATA

	2", 2.5"	3"	4"
<b>Maximum Pump Speed</b>	815 RPM	700 RPM	563 RPM
<b>Maximum Viscosity</b>	20,000 SSU (4,250 cP)		
<b>Maximum Operating Temperature *</b>	240 – 300°F (115 – 149°C)		
<b>Maximum Differential Pressure</b>	125 psi (8.6 Bar)		
<b>Maximum Working Pressure</b>	175 psi (12.1 Bar)		

\* Maximum operating limits are dependent on the materials of construction. See Blackmer Material Specs 101-096.

#### INITIAL PUMP START UP INFORMATION

<b>Model No.:</b> _____
<b>Serial No.:</b> _____
<b>ID No.:</b> _____
<b>Date of Installation:</b> _____
<b>Inlet Gauge Reading:</b> _____
<b>Discharge Gauge Reading:</b> _____
<b>Flow Rate:</b> _____

# INSTALLATION

## NOTICE:

Blackmer pumps must only be installed in systems designed by qualified engineering personnel. System design must conform with all applicable regulations and codes and provide warning of all system hazards.

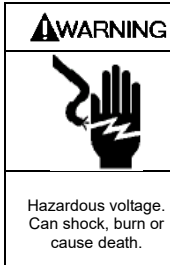

- ⚠ Install, ground and wire to local and National Electrical Code requirements.
- ⚠ Install an all-leg disconnect switch near the unit motor.
- ⚠ Disconnect and lockout electrical power before installation or service
- ⚠ Electrical supply MUST match motor nameplate specifications.

⚠ Motors equipped with thermal protection automatically disconnect motor electrical circuit when overload exists. Motor can start unexpectedly and without warning.

## PRE-INSTALLATION CLEANING

### NOTICE:

New pumps contain residual test fluid and rust inhibitor. If necessary, flush pump prior to use.

Foreign matter entering the pump WILL cause extensive damage. The supply tank and intake piping MUST be cleaned and flushed prior to pump installation and operation.

## LOCATION AND PIPING

Pump life and performance can be significantly reduced when installed in an improperly designed system. Before starting the layout and installation of the piping system, review the following:

1. Locate the pump as near as possible to the source of supply to avoid excessive inlet pipe friction.
2. The inlet line MUST be at least as large as the intake port on the pump. The inlet piping should slope downward to the pump without any upward loops. Eliminate restrictions such as sharp bends; globe valves, unnecessary elbows, and undersized strainers.
3. It is recommended a strainer be installed in the inlet line to protect the pump from foreign matter. The strainer should be located at least 24" (0.6m) from the pump, and have a net open area of at least four times the area of the intake piping. For viscosities greater than 1000 SSU, consult the strainer manufacture instructions. Strainers must be cleaned regularly to avoid pump starvation.
4. The intake system must be free of air leaks.
5. Expansion joints, placed at least 36" (0.9m) from the pump, will compensate for expansion and contraction of the pipes. Contact the flexible connector/hose manufacturer for required maintenance/care and design assistance in their use.
6. Install pressure gauges in the NPT ports provided in the pump casing to check pump at start up.

7. ALL piping and fittings MUST be properly supported to prevent any piping loads from being placed on the pump.
8. Check alignment of pipes to pump to avoid strains which might later cause misalignment. See Figure 1. Unbolt flanges or break union joints. Pipes should not spring away or drop down. After pump has been in operation for a week or two, completely recheck alignment.

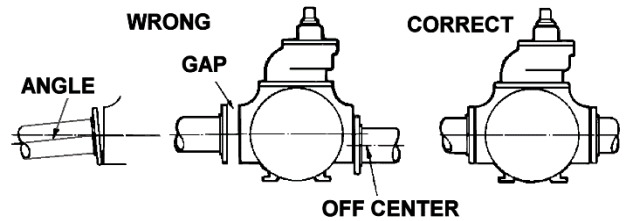

Figure 1

9. When pumping liquids at elevated temperature, provisions should be made to compensate for expansion and contraction of the pipes, especially when long pipe lines are necessary. Steel pipe expands approximately 3/4" (1.9 cm) per 100 feet (30.49 m) per 100°F (37.8°C) rise in temperature.

## PUMP MOUNTING

A solid foundation reduces noise and vibration, and will improve pump performance. On permanent installations it is recommended the pumping unit be secured by anchor bolts as shown in Figure 2. This arrangement allows for slight shifting of position to accommodate alignment with the mounting holes in the base plate.

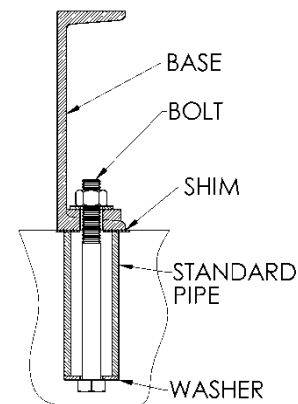

Figure 2 - Pipe Type Anchor Bolt Box

For new foundations, it is suggested that the anchor bolts be set in concrete. When pumps are to be located on existing concrete floors, holes should be drilled into the concrete to hold the anchor bolts.

When installing units built on channel or structural steel type bases, use care to avoid twisting the base out of shape when anchor bolts are tightened. Shims should be used under the edges of the base prior to tightening of the anchor bolts to prevent distortion.

## COUPLING ALIGNMENT – FOOTED GEARBOX

The following pertains to units with non-standard, footed gearboxes only. Standard GNX(H) units will not require manual alignment.

The pump must be directly coupled to a gear and/or driver with a flexible coupling. Verify coupling alignment after installation of new or rebuilt pumps. Both angular and parallel coupling alignment **MUST** be maintained between the pump, gear, motor, etc. in accordance with manufacturer's instructions. See Figure 3.

1. Parallel alignment: The use of a laser alignment tool or dial indicator is preferred. If a laser alignment tool or dial indicator is not available, use a straightedge. Turn both shafts by hand, checking the reading through one complete revolution. Maximum offset should be less than .005" (.127 mm).
2. Angular alignment: Insert a feeler gauge between the coupling halves. Check the spacing at 90° increments around the coupling (four checkpoints). Maximum variation should not exceed .005" (.127 mm). Some laser alignment tools will check angular alignment as well.
3. Replace the coupling guards after setting alignment.

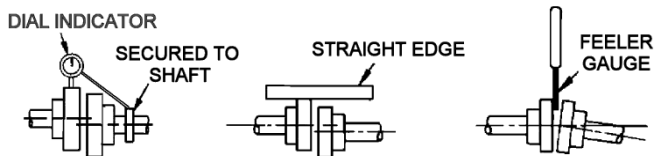
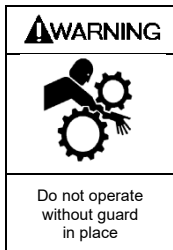

Figure 3 – Alignment Check



**Operation without guards in place can cause serious personal injury, major property damage, or death.**

## ALIGNMENT – GNX(H) MODELS

The motor, gearbox, and pump are rigidly connected with bolted, flange connections. These flanges ensure the motor shaft, gearbox shafts, and pump shaft are aligned correctly, without the need for manual alignment. However, due to variations in base and foundation geometry the unit will require shimming to reduce stress on the gearbox and pump adapter. See *PRESTART CHECKLIST* section for details.

## NEMA MOTOR COUPLING ADAPTER

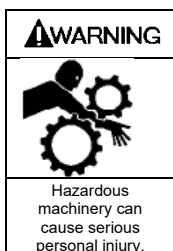

**Failure to disconnect and lockout electrical power or engine drive before attempting maintenance can cause severe personal injury or death**

Motor adapters allow for easy installation and removal of industry standard motors. Motor adapters consist of a coupling and an adapter housing that connects the motor to the gear reducer.

NORD Gear supplies a coupling that is to be mounted on the motor shaft. It is important that the coupling is properly positioned.

- For NEMA Input Adapters, follow the Motor Installation Instructions on page 5.
- For IEC Input Adapters, the supplied coupling will mount directly against the motor shaft shoulder. No locating measurements need to be taken.

## Couplings

Couplings are made with tough abrasion resistant materials, which resist most chemicals and petroleum products. They are electrically isolated (prevent metal to metal contact) and require no lubrication or maintenance. Depending upon the size of the C-face input, NORD provides either a gear or a jaw type coupling.

NORD supplies three different types of couplings depending on the size of input: "J" style, "M" style and "Jaw" style coupling.

Following are instructions on how to properly mount each type of coupling onto the motor.

## BoWex® Couplings

NORD C-face adapter input shafts have a machined spline on the end. NORD incorporates two styles of BoWex® couplings, the "J" and "M" styles. The "J" style is a one-piece coupling with a metal hub and nylon spline. The "M" style is a two-piece coupling – the metal hub and a nylon sleeve.

- Nylon sleeves resist dirt, moisture, most chemicals and petroleum products
- No lubrication required
- Operating Conditions: -22°F - 212°F (-30°C - 100°C)
- Higher temperature coupling sleeve available up to 250°F (120°C)
- Special bore available

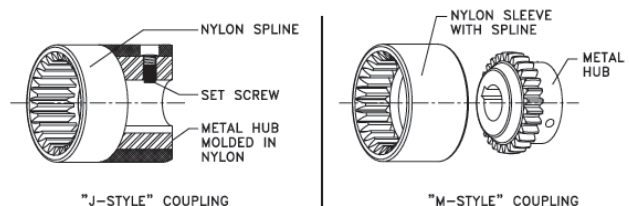

NEMA Motor Coupling Styles

**BoWex® Couplings Mechanical Ratings "J" Style (NEMA & IEC)**

Coupling Type	Rated Torque		Input Adapter Sizes	Bore Size
	Cont. (Lb-in)	Peak (N-m)		
BoWex® J14	44.3	88.5	N56C	5/8"
BoWex® J24	106	212	N140TC	7/8"
BoWex® J28	398	1,195	N180TC	1-1/8"
	45	135	N180TC1	

**BoWex® Couplings Mechanical Ratings "M" Style (NEMA & IEC)**

Coupling Type	Rated Torque		Input Adapter Sizes	Bore Size
	Cont. (Lb-in)	Peak (N-m)		
BoWex® M38	708	2,124	N180TC, N210TC, N250TC*	1-1/8", 1-3/8"
BoWex® M42	885	2,655	N250TC*	1-5/8"
BoWex® M48	1,239	3,717	N280TC	1-7/8"
	140	420		

\*GNX(H)2/2.5 N250TC Frame size uses BoWex® M38

\*GNX(H)3/4 N250TC Frame size uses BoWex® M42

**Rotex® Couplings**

The cast iron jaw type couplings have an integral urethane "spider" that provides smooth transmission of the motor torque. A set screw on the coupling prohibits axial movement along the motor shaft.

- Excellent shock and vibration dampening
- Excellent resistance to oils and most chemicals
- No metal-to-metal contact
- Operating Conditions: -22°F - 195°F (-30°C - 90°C)
- Higher temperature material (Hytrel) spider available up to 230°F (110°C)
- Low temperature materials available upon request
- Special bores available

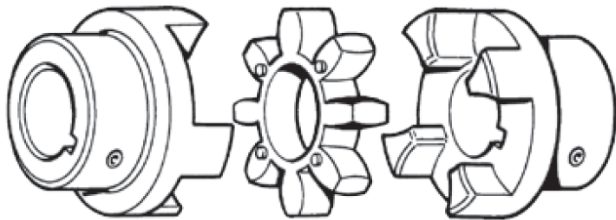

**Rotex® Couplings Mechanical Ratings "R" Style (NEMA & IEC)**

Coupling Type	Rated Torque		Input Adapter Sizes	Bore Size
	Cont. (Lb-in)	Peak (N-m)		
Rotex® R65	5,532	11,063	N320TC	2-3/8"
Rotex® R90	21,242	42,484	N360TC	1-5/8"
	625	1,250		
	2400	4800		

**"J" Style Coupling NEMA C-face Motor Installation**

1. Measure the distance from the face of the input adapter to the face of the splined shaft and record that measurement as A in the equation below.

2. Measure depth of coupling engagement zone and record the measurement as "B" in the equation below.
3. Add "A" + "B" and subtract 0.08" (~2mm) from the distance. This needs to be done so that the coupling will not be preloaded after installation!
4. Use that measurement to locate the coupling from the face of the motor onto the shaft.
5. Once in place, tighten the set screw to lock the coupling in place. It is recommended that the key is staked or bonded (Loctite® 262) in place to prohibit the key from vibrating out.
6. Mount the motor onto the input adapter with customer supplied bolts. Make sure that the coupling from the adapter and the motor engage securely. Use lock washers or Loctite to prohibit bolts from becoming loose from vibration.

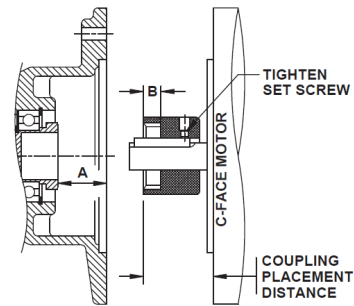

$$\begin{array}{r} \text{MEASURED DISTANCES} \\ A + B \\ \hline - 0.080" (2\text{mm}) = \\ \hline \text{COUPLING PLACEMENT DISTANCE} \end{array}$$

"J" Style NEMA Motor Coupling Installation

**"M" Style Coupling NEMA C-face Motor Installation**

1. Measure the distance from the face of the input adapter to the face of the splined shaft & record that measurement.
2. Subtract 0.31" (~8mm) from the distance. This needs to be done so that the coupling will not be preloaded after installation!
3. Use that measurement to locate the coupling from the face of the motor onto the shaft.
4. Apply Loctite® 7471 (primer) to the key, keyway, set screws, and threaded holes in the hub. Wait 60 seconds to dry.
5. Apply Loctite® 262 to key and install into shaft. Apply Loctite® 262 to setscrews.
6. Once in place, tighten the set screws to 156 in-lbf to lock the coupling in place.
7. Mount the motor onto the input adapter with customer supplied bolts. Make sure that the coupling from the adapter and the motor engage securely. Use lock washers or Loctite to prohibit bolts from becoming loose from vibration.

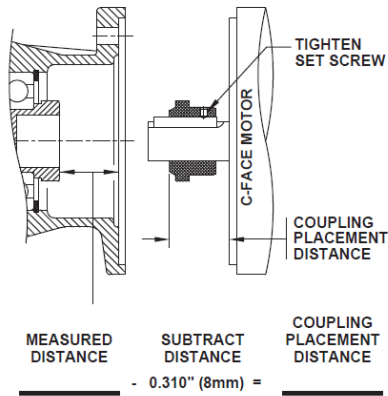

"M" Style NEMA Motor Coupling Installation

Coupling Size	"X" (Subtract this value from measured distance)
R14	0.06" (1.5 mm)
R19 & 24	0.08" (2.0 mm)
R28	0.10" (2.5 mm)
R38 & 42	0.12" (3.0 mm)
R48	0.14" (3.5 mm)
R65	0.18" (4.5 mm)
R90	0.22" (5.5 mm)

### "Jaw" Style Coupling NEMA C-face Installation

1. Measure the distance from the face of the input adapter to the face of the coupling as shown and record that measurement.
2. Subtract the "X" dimension from the measured distance. This needs to be done so that the coupling will not be preloaded after installation!
3. Use that measurement to locate the coupling from the face of the motor onto the shaft.
4. The metal portion of the coupling should be heated up prior to assembly, generally 250°F to 300°F (120°C to 150°C).

### Notice: DO NOT HEAT URETHANE SPIDER

5. Once in place, tighten the setscrew to lock coupling in place. Let the coupling cool down before placing the spider into the jaws. It is recommended that the key is staked or bonded (Loctite) in place to prohibit the key from vibrating out.
6. Mount the motor onto the input adapter with customer supplied bolts. Make sure that the coupling from the adapter and the motor engage securely. Use lock washers or Loctite to prohibit bolts from becoming loose from vibration.

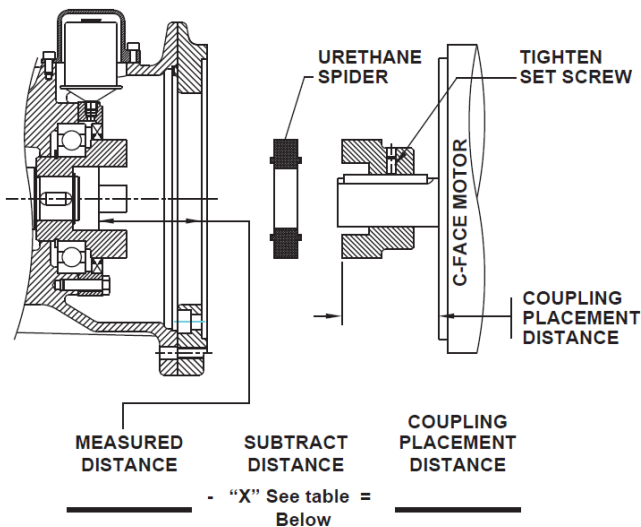

Jaw Style NEMA Motor Coupling Installation

## **PUMP ROTATION**

A right-hand pump rotates clockwise with the intake and relief valve on the right side, when viewed from the driven end.

A left-hand pump rotates counterclockwise with the intake and relief valve on the left side, when viewed from the driven end.

### **NOTICE:**

**On GNX(H) models, the gear reducer input shaft will rotate in the opposite direction of the pump shaft. For example, on a right-hand GNX(H) pump, the gear reducer shaft will rotate counterclockwise. The motor fan can be used to ensure proper rotation.**

### **NOTICE:**

**Confirm correct pump rotation by checking the pump rotation arrows respective to pump driver rotation.**

## **TO CHANGE PUMP ROTATION**

To reverse rotation, the pump must be disassembled then reassembled with the shaft on the opposite side of the pump. See the 'Maintenance' section for instructions.

## **CHECK VALVES**

The use of check valves or foot valves in the supply tank is not recommended with self-priming, positive displacement pumps.

If the possibility of liquid backflow exists when the pump is off, a check valve in the pump discharge piping is recommended because the pump can motor in the reverse rotation and create undue stress on all attached components. Never start a pump when it is rotating in the reverse rotation as the added starting torque can damage the pump and related equipment.

# OPERATION

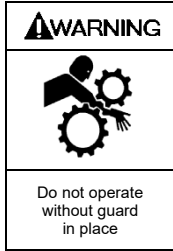

Operation without guards in place can cause serious personal injury, major property damage, or death.

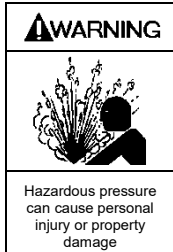

Disconnecting fluid or pressure containment components during pump operation can cause serious personal injury, death or major property damage

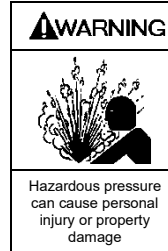

Failure to relieve system pressure prior to performing pump service or maintenance can cause personal injury or property damage.

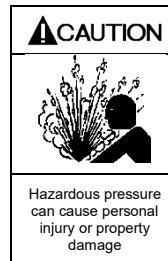

Pumps operating against a closed valve can cause system failure, personal injury and property damage

## PRE-START UP CHECK LIST

1. Check the alignment of the pipes to the pump. Pipes should be supported so that they do not spring away or drop down when pump flanges or union joints are disconnected.
2. Verify proper coupling alignment on long coupled units.
3. For GNX(H) models:
  - 3a. Bolt down the pump foot, while supporting the motor with an appropriate lifting device (e.g. crane)
  - 3b. Place a .125" thick shim under each of the motor mounting holes
  - 3c. Slowly lower the motor until it is unsupported
  - 3d. Try pulling out each of the shims, while noticing the pull tension
  - 3e. If the shims closest to the motor shaft easily pull out, increase the shim thickness the same at all locations and recheck
  - 3f. If the shims furthest from the motor shaft easily pull out, decrease the shim thickness the same at all locations and recheck
  - 3g. The unit is properly shimmed when all 4 motor shims have the same amount of tension when pulled
  - 3h. Bolt down the motor with the appropriate fastener.
4. The GNX(H)2 and GNX(H)2.5 gearbox will be shipped with Mobil SHC630 synthetic oil. The GNX(H)3 and GNX(H)4 will be shipped with Mobil SHC Gear 220 synthetic oil. If replacing the oil, refer to the **GEAR REDUCER MAINTENANCE** section.
5. **the factory. The inboard bearing MUST be greased after installation of the gear reducer and prior to initial pump start up.** See "Pump Lubrication" in the Maintenance section of this manual.
6. Check the entire pumping system to verify that the proper inlet and discharge valves are fully open, and that the drain valves and other auxiliary valves are closed.
7. Install vacuum and pressure gauges on the pump in the 1/4" NPT connections provided to check suction and discharge conditions after pump start-up.
8. Check the wiring of the motor, and briefly turn on the power to make sure that the pump rotates in the direction of the rotation arrow.

### NOTICE:

The GNX(H) Gear Reducer is shipped with the correct amount of synthetic oil. If the unit will be orientated in a non-standard way, please consult the factory for lubrication information

5. On GNX(H) models shipped without the gear reducer attached, the inboard bearings are NOT greased at



## START UP PROCEDURES

### NOTICE:

Consult the "General Pump Troubleshooting" section of this manual if difficulties during start up are experienced.

1. Start the motor. Priming should occur within one minute.
2. Check the suction and discharge pressure to see if the pump is operating within the expected conditions. Record pressures in the 'Initial Start Up Information' section.
3. Check for leakage from the piping and equipment.
4. Check for overheating, excessive noise or vibration of the pump, reducer, and motor.
5. Check the flow rate to ensure the pump is operating within the expected parameters. Record flow rate in the 'Initial Start Up Information' section.
6. Check the pressure setting of the relief valve by briefly closing a valve in the discharge line and reading the pressure gauge. This pressure should be 20 psi (1.4 bar) higher than the maximum operating pressure.

**Do not run the pump for more than 15 seconds with the discharge valve completely closed.**

If adjustments need to be made, refer to "Relief Valve Setting & Adjustment."

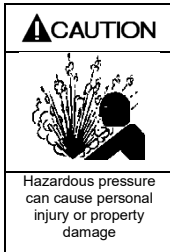

**Incorrect settings of the pressure relief valve can cause pump component failure, personal injury, and property damage.**

## RUNNING THE PUMP IN REVERSE ROTATION

### NOTICE:

Pump should be operated in reverse rotation for no more than 10 minutes and only when a separate pressure relief valve is installed to protect the pump from excessive pressure.

It may be desirable to run the pump in reverse rotation for system maintenance. The pump will operate satisfactorily in reverse rotation for a LIMITED time, at a reduced performance level.

## FLUSHING THE PUMP

### NOTICE:

If flushing fluid is to be left in the pump for an extended time, it must be a lubricating, non-corrosive fluid. If a corrosive or non-lubricating fluid is used, it must be flushed from the pump immediately.

1. To flush the pump, run the pump with the discharge valve open and the intake valve closed. Bleed air into the pump through the intake gauge plug hole or through a larger auxiliary fitting in the intake piping. Pump air for 30 second intervals to clean out most of the pumpage.
2. Run a system compatible flushing fluid through the pump for one minute to clear out the remainder of the original pumpage.
3. To remove the flushing fluid, follow step 1 above.

### NOTICE:

After flushing the pump some residual fluid will remain in the pump and piping.

### NOTICE:

Properly dispose of all waste fluids in accordance with the appropriate codes and regulations.

## PUMP RELIEF VALVE

### NOTICE:

The pump internal relief valve is designed to protect the pump from excessive pressure and must not be used as a system pressure control valve.

GNX(H) series pumps are fitted with an internal pressure relief valve that bypasses back to the suction side of the pump.

Pumping volatile liquids under suction lift may cause cavitation. Partial closing of the discharge valve WILL result in internal relief valve chatter and is NOT recommended. For these applications, install an external system pressure control valve, and any necessary bypass piping, back to the storage tank.

A system pressure control valve is also recommended when operating for extended periods (more than 1 minute) against a closed discharge valve.

## RELIEF VALVE SETTING AND ADJUSTMENT

The relief valve pressure setting is marked on a metal tag attached to the valve cover. Generally, the relief valve should be set at least 15 - 20 psi (1.0 - 1.4 Bar) higher than the operating pressure, or the external bypass valve setting (if equipped).

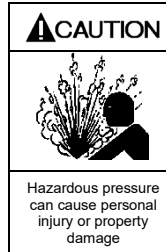

Incorrect settings of the pressure relief valve can cause pump component failure, personal injury, and property damage.

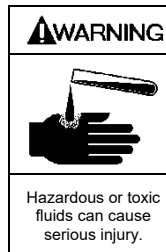

Relief valve cap is exposed to pumpage and will contain some fluid

**DO NOT remove the R/V Cap OR adjust the relief valve pressure setting while the pump is in operation.**

1. **To INCREASE the pressure setting**, remove the relief valve cap (1) and gasket (88). Loosen the locknut(3), if equipped. Turn the adjusting screw (2) *inward*, or clockwise. Inspect the R/V cap gasket (88) and replace as required. Reattach the R/V cap gasket and cap.
2. **To DECREASE the pressure setting**, remove the relief valve cap (1) and gasket (88). Loosen the locknut(3), if equipped. Turn the adjusting screw (2) *outward*, or counterclockwise. Inspect the R/V cap gasket (88) and replace as required. Reattach the R/V cap gasket and cap.

Refer to the individual Blackmer pump parts lists for various spring pressure ranges. Unless specified otherwise, pumps are supplied from the factory with the relief valve adjusted to the mid-point of the spring range.

# MAINTENANCE

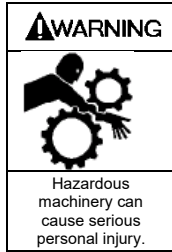

Failure to disconnect and lockout electrical power or engine drive before attempting maintenance can cause severe personal injury or death

Hazardous machinery can cause serious personal injury.

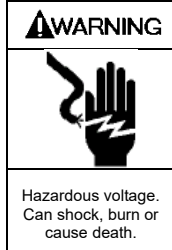

Failure to disconnect and lockout electrical power before attempting maintenance can cause shock, burns or death

Hazardous voltage. Can shock, burn or cause death.

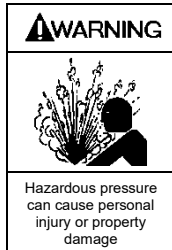

Failure to relieve system pressure prior to performing pump service or maintenance can cause personal injury or property damage.

Hazardous pressure can cause personal injury or property damage

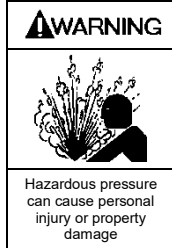

Disconnecting fluid or pressure containment components during pump operation can cause serious personal injury, death or major property damage

Hazardous pressure can cause personal injury or property damage

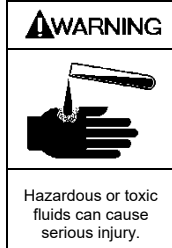

If pumping hazardous or toxic fluids, system must be flushed and decontaminated, inside and out, prior to performing service or maintenance

Hazardous or toxic fluids can cause serious injury.

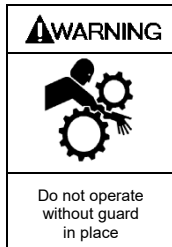

Operation without guards in place can cause serious personal injury, major property damage, or death.

Do not operate without guard in place

## NOTICE:

Maintenance shall be performed by qualified technicians only. Follow the appropriate procedures and warnings as presented in this manual.

## SCHEDULED MAINTENANCE

### LUBRICATION

## NOTICE:

To avoid possible entanglement in moving parts do not lubricate pump bearings, gear reducer or any other parts while the pump is running.

## NOTICE:

The inboard bearings of GNX(H) models shipped without the gear reducer attached are NOT greased at the factory. The inboard bearing MUST be greased after installation of the gear reducer and prior to initial pump start up.

## NOTICE:

If pumps are repainted in the field, ensure that the grease relief fittings (76A) are functioning properly after painting. Do NOT paint them closed. Remove any excess paint from the fittings.

Pump bearings should be lubricated every three months at minimum. More frequent lubrication may be required, depending on the application and operating conditions.

### Recommended Grease:

Mobil® - Mobilgrease XHP222,  
Exxon® - RONNEX MP Grease,  
or equivalent Lithium grease..

### Greasing Procedure:

1. Remove the grease relief fittings (76A) from the bearing covers (27, 27A).
2. **SLOWLY** apply grease with a hand gun until grease begins to escape from the grease relief fitting port. (76)
3. Replace the grease relief fittings (76A).

DO NOT overgrease pump bearings. While it is normal for some grease to escape from the grease tell-tale hole after lubrication, excessive grease on pumps equipped with mechanical seals can cause seal failure.

If equipped with a Blackmer gear reducer, refer to the 'Gear Reducer Lubrication' section of this manual.

## STRAINERS

Strainers must be cleaned regularly to avoid pump starvation. Schedule will depend upon the application and conditions.

## VANE REPLACEMENT

### NOTICE:

Maintenance shall be performed by qualified technicians only. Follow the appropriate procedures and warnings as presented in manual.

1. Flush the pump per instructions in this manual. Drain and relieve pressure from the pump and system as required.
2. Remove the head assembly from the **outboard** (nondriven) side of the pump according to steps 5 - 8 in the "Pump Disassembly" section of this manual.
3. Turn the shaft by hand until a vane comes to the top (12 o'clock) position of the rotor. Remove the vane.
4. Install a new vane, ensuring that the rounded edge is UP, and the relief grooves are facing towards the direction of rotation. See Figure 4.
5. Repeat steps 3 and 4 until all vanes have been replaced.
6. Reassemble the pump according to the "Pump Assembly." section of this manual.

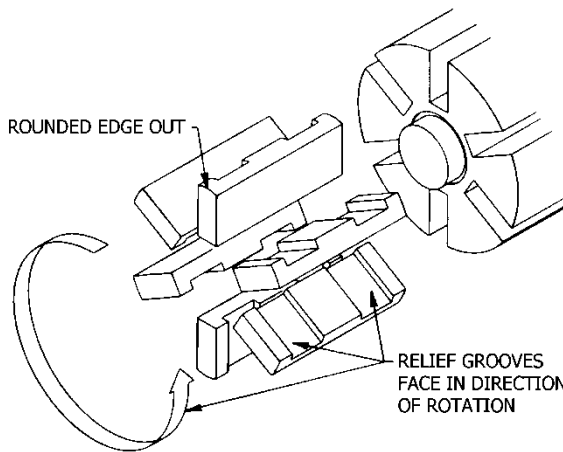

Figure 4 – Vane Replacement

## PUMP DISASSEMBLY

### NOTICE:

Follow all hazard warnings and instructions provided in the "Pump Maintenance" section of this manual.

1. Flush the pump per instructions in this manual. Drain and relieve pressure from the pump and system as required.
2. Remove the four adapter capscrews (20C) to release the adapter (135). Remove the motor mounting bolts. With the aid of a lifting device, slide the motor and gearbox away from the pump. Refer to "Gear Reducer Maintenance" for reducer disassembly instructions.
3. Starting on the **inboard** (driven) end of the pump, clean the pump shaft thoroughly, making sure the shaft is free of nicks and burrs. This will prevent damage to the mechanical seal when the inboard head assembly is removed.
4. Remove the outboard bearing cover capscrews (28) and the outboard bearing cover (27) and bearing cover gasket (26). Discard the bearing cover gasket.
5. **The GNX(H)2 and GNX(H)2.5** are equipped with locknuts (24A) and lockwashers (24B). To remove:
  - a. Bend up the engaged lockwasher tang and rotate the locknut counterclockwise to remove it from the shaft.
  - b. Slide the lockwasher off the shaft. Inspect the lockwasher for damage and replace as required.

- c. Repeat steps a and b on the opposite shaft end.
6. Remove the head capscrews (21). Gently pry the head away from the cylinder.
  7. Slide the head off the shaft. The head O-ring (72), bearing (24), and mechanical seal (153) will come off with the head assembly. Remove and discard the head O-ring.
    - a. Pull the bearing (24) from the housing in the head.
    - b. To remove the mechanical seal, use two screw drivers against the backside of the seal jacket to gently push the seal from the head (see Figure 5). Use care when placing the screw drivers to prevent damage to the seal faces. Remove and discard the seal O-rings.

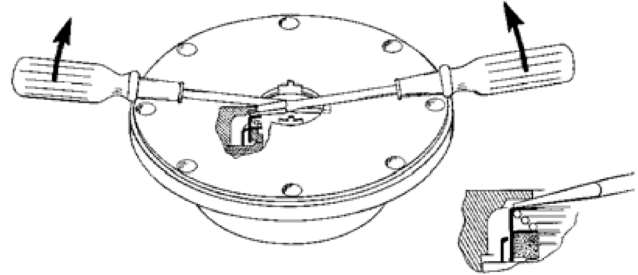

Figure 5 – Mechanical Seal Removal

8. Pull the rotor and shaft (13) from the cylinder. While one hand is pulling the shaft, the other hand should be cupped underneath the rotor to prevent the vanes (14) and push rods (77) from falling out. Carefully set the rotor and shaft aside for future vane replacement and reassembly.
9. Remove the remaining components from the outboard side of the pump, as instructed in steps 7 and 8 above.

## PARTS REPLACEMENT

1. If any of the O-rings have been removed or disturbed during disassembly, they should be replaced with new O-rings.

**NOTE:** PTFE O-rings should be heated in hot water to aid installation.
2. Excessive or continuous leakage from the tell-tale hole in the bearing cover may be an indication of a damaged mechanical seal. If a mechanical seal has been leaking, it is recommended the entire seal be replaced. Refer to "General Pump Troubleshooting" for possible causes of seal leakage.

## PUMP ASSEMBLY

**Before reassembling the pump, inspect all component parts for wear or damage, and replace as required. Wash out the bearing/seal recess of the head and remove any burrs or nicks from the rotor and shaft.**

1. **Reassemble the OUTBOARD side of the pump first:**  
For a CLOCKWISE rotation pump, position the pump cylinder with the INTAKE port to the **left**.  
For a COUNTERCLOCKWISE rotation pump, position the pump cylinder with the INTAKE port to the **right**.
2. Apply a small amount of quality O-ring lubricant in the head recess. With new O-rings installed, push the mechanical seal assembly (153) into the recess of the head with the seal jacket drive tangs inward. The pin in the seal stationary seat **MUST** be between the lugs in the back of the head recess.
3. Apply a small amount of O-ring lubricant to the O-ring groove on the inside face of the head to facilitate installation. Install a new head O-ring (72) in the groove by laying the O-ring flat and starting in on one side of the groove, stretching ahead with the fingers, as shown in Figure 8.

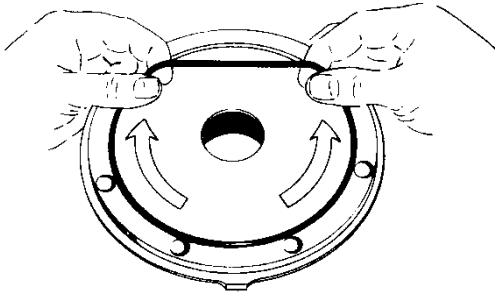

Figure 8 – Head O-Ring Installation

4. Install the head (20) on the outboard side of the cylinder. Install and snug up four head capscrews (21) 90° apart.
5. Hand pack the ball bearing (24) with grease. Refer to "Lubrication" in the Pump Maintenance Section for the recommended grease.
6. Install the bearing into the head recess. The bearing balls should face outward, with the grease shield inward. Ensure the bearing is fully and squarely seated against the mechanical seal.
7. Turn the pump cylinder around and begin assembly on the opposite, inboard end.
8. Remove the vanes (14) and push rods (77) from the rotor and shaft assembly. Inspect for wear and damage, and replace as follows:
  - a. Partially install the non-driven end of the rotor and shaft (13) into the open side of the pump cylinder.
  - b. Leave part of the rotor outside of the cylinder so that the bottom vanes can be installed and held in place as the push rods are installed in the push rod holes of the rotor. Insert the new vanes into the rotor slots with the rounded edges outward, and the vane relief grooves facing TOWARDS the direction of rotation. Refer to Figure 4 in "Vane Replacement."
  - c. After the bottom vanes and push rods are installed, insert the rotor and shaft fully into the cylinder.
  - d. Install the remaining vanes into the top positions of the rotor. **Rotate the shaft by hand to engage the drive tangs of the mechanical seal jacket in the rotor slots.**

9. Apply a thin coating of quality O-ring lubricant on the inboard shaft to aid installation. Install the inboard head, mechanical seal, and bearing as instructed in steps 2 through 6.
10. Rotate the shaft by hand to engage the seal drive tangs, and to test for binding or tight spots. If the rotor does not turn freely, lightly tap the rims of the heads with a soft faced mallet until the correct position is found. Install all of the remaining head capscrews for each head and uniformly tighten, then torque to 25 lbs ft (34 Nm).

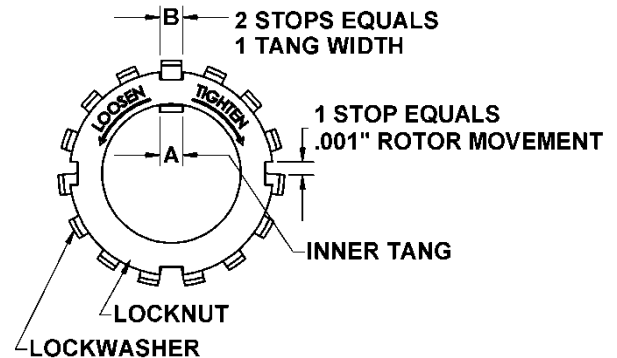

Figure 9 – Locknut Assembly

### 11. LOCKNUT ADJUSTMENT – 2", 2.5", 3" Models

It is important that the bearing locknuts (24A) and lockwashers (24B) be installed and adjusted properly. Overtightening locknuts can cause bearing failure or a broken lockwasher tang. Loose locknuts will allow the rotor to shift against the heads, causing wear. See Figure

- a. On both ends of the pump shaft, install a lockwasher (24B) with the tangs facing outward, followed by a locknut (24A) with the tapered end inward. Ensure the inner tang "A" of the lockwasher is located in the slot in the shaft threads, bending it slightly, if necessary.
- b. Tighten both locknuts to ensure that the bearings are bottomed in the head recess. **DO NOT overtighten and bend or shear the lockwasher inner tang.**
- c. Loosen both locknuts one complete turn.
- d. Tighten one locknut until a slight rotor drag is felt when turning the shaft by hand.
- e. Back off the nut the width of one lockwasher tang "B". Secure the nut by bending the closest aligned lockwasher tang into the slot in the locknut. The pump should turn freely when rotated by hand.
- f. Tighten the opposite locknut by hand until it is snug against the bearing. Then, using a spanner wrench, tighten the nut the width of one lockwasher tang "B". Tighten just past the desired tang, then back off the nut to align the tang with the locknut slot. Secure the nut by bending the aligned lockwasher tang into the slot in the locknut. The pump should continue to turn freely when rotated by hand.
- g. To check adjustment, grasp the nut and washer with fingers and rotate back and forth. If this cannot be done, one or both locknuts are too tight and should be alternately loosened one stop at a time 0.001" (0.025mm). Begin by loosening the locknut adjusted last.

## 12. LOCK COLLAR ADJUSTMENT – 4” Models

It is important that the bearing Lock Collar (24A) be installed and adjusted properly. Overtightening the Lock Collar Adjustment Tool Screws during installation can cause bearing failure or excessive pump power draw. Loose Lock Collar Adjustment Tool Screws will allow the rotor to shift against the heads, causing wear.

- a. On both ends of the pump shaft, install a Lock Collar (24A) with the socket head cap screws facing upward.
- b. Starting with the Outboard side of the pump, attach the Lock Collar Adjustment Tool to the Outboard Head (23). See Figure 10. Align the inner hole pattern of the tool with the corresponding tapped holes in the head. Ensure that the large center hole of the tool is centered on the shaft.
- c. Slowly turn the Lock Collar Adjustment Tool screws, which will move the Lock Collar and Bearing towards the Outboard Head (23). Alternate between each screw so that even pressure is applied to the Lock Collar. Once the Bearing (24) stops moving into the head, is slightly recessed in the head bore, and the force required to turn the screws increases stop turning the screws.
- d. Tighten 5/16” screws on lock collar to 20 ft-lbf. Make sure that the 3/8” set screws are loosened, so they do not contact the shaft. Ensure an even gap on each split of the collar.
- e. Remove Lock Collar Adjustment Tool.
- f. Tighten 3/8” set screws on Lock Collar to 20 ft-lbf.
- g. Move Lock Collar Adjustment Tool to Inboard side and repeat steps 12a through 12f. See figure 11 for Inboard Side tool assembly.
- h. Spin shaft to make sure it turns smoothly.

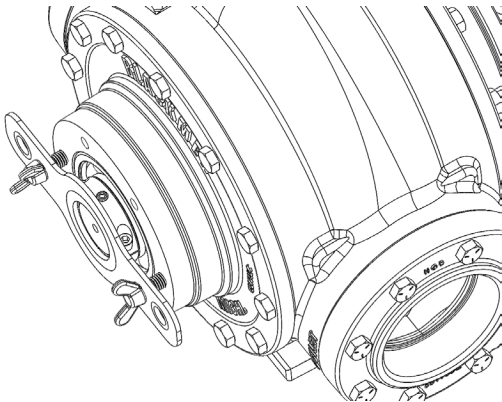

Figure 10 – Lock Collar Assembly, Outboard

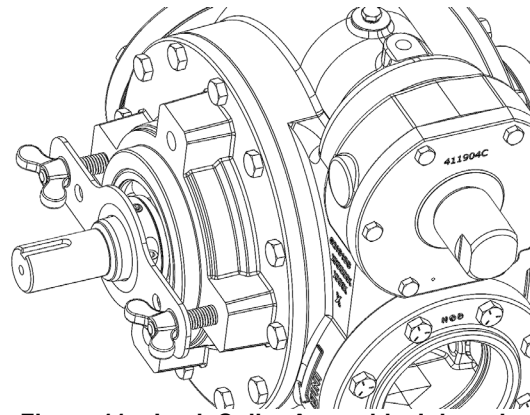
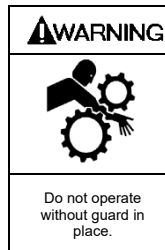

Figure 11 – Lock Collar Assembly, Inboard

13. Attach a new bearing cover gasket (26) and the outboard bearing cover (27) to the outboard head. Install and torque the bearing cover capscrews (28) to 15 ft-lbf (20 Nm).
  14. Lightly oil Adapter O-ring (135B) and install on inboard head.
  15. Ensure the key (35) is installed on the pump shaft. With the aid of a lifting device, slide the motor and gearbox assembly towards the pump engaging gearbox shaft receiver with the pump shaft.
  16. Install the Adapter screws (20C) into the inboard head and torque to 23 ft-lbf.
- ### 17. RELIEF VALVE ASSEMBLY
- a. Insert the valve (9) into the relief valve bore of the casing with the fluted end inward.
  - b. Install the relief valve spring (8) and spring guide (7) against the valve.
  - c. Attach a new relief valve O-ring (10) and the valve cover (4) on the cylinder.
  - d. Screw the relief valve adjusting screw (2) with locknut (3) into the valve cover (4) until it makes contact with the spring guide (7).
  - e. After the relief valve has been adjusted, tighten the Locknut (3) and install the relief valve cap (1) and O-ring (88).

#### NOTICE:

The relief valve setting **MUST** be tested and adjusted more precisely before putting the pump into service. Refer to "Relief Valve Setting and Adjustment"



Operation without guards in place can cause serious personal injury, major property damage, or death.

18. Reinstall coupling, shaft key, and coupling guards.
19. Refer to "Pre-Start Up Check List" and "Start Up Procedures" sections of this manual prior to restarting pump operation.

---

# GEAR REDUCER MAINTENANCE

## NOTICE:

Detailed maintenance instructions for the gearbox can be found at [www.nord.com/docs](http://www.nord.com/docs). The following are excerpts from those documents and should be treated as reference only.

## STORAGE

### NOTICE:

For storage periods longer than 9 months, or for storage in less than desirable conditions, please consult NORD for recommendations.

- Storage for up to 9 months is possible, so long as the following conditions are observed:
- Store the gear unit in its actual mounting position in accordance with the specified oil fill-level, in a clean and dry temperature controlled area. Avoid temperature fluctuations within the range of 0°C and 40°C (32°F to 104°F) and avoid relative humidity conditions in excess of 60%.
- Protect all exposed or unpainted shaft and flange surfaces with an anti-corrosion agent or grease.
- Store in a location free from shock and vibration, to avoid false brinelling of bearing elements and raceways.
- Whenever possible, rotate the shafts periodically, by hand if necessary, to help prevent brinelling (bearing damage) and to help keep the shaft seals pliable.
- Avoid direct exposure to the sun or UV light and aggressive or corrosive materials in the environment (ozone, gases, solvents, acids, caustic solutions, salts, radioactivity, etc).

## Commissioning

Prior to gear unit start-up, complete the following:

- Please check your gear unit for a vent and if applicable to your product, remove the sealing plug to activate

### NOTICE:

To prevent build-up of excessive pressure, sealed vents must be activated as shown prior to gear unit start up. Excessive pressure may cause damage to internal gearbox components and leakage.

- Check the lubricant and be sure the gear unit is filled with the proper oil type, to the proper level, as determined by the mounting position.
- Check the condition of all shaft seals and all assembled flange gasket areas. If any change is detected in the shape, color, hardness or permeability, or if any leaks are detected, the corresponding shaft seals and/or gaskets must be replaced.
- Remove all anti-corrosive metal protectant from otherwise bare metal surfaces. Follow product manufacturer's directions and warnings during surface protection removal.

- Check the resistance of all motor and brake windings to verify the integrity of the winding insulation and inspect all terminal box openings and wire connection areas to verify that all components are dry and free of corrosion.

## Long Term Storage

By taking special precautions, problems such as seal leakage and reducer failure due to the lack of lubrication, improper lubrication quantity, or contamination can be avoided. The following precautions will protect gear reducers during periods of extended storage:

- Store the gear unit in its actual mounting position in accordance with the specified oil fill-level, in a clean and dry temperature controlled area. Avoid temperature fluctuations within the range of 0°C and 40°C (32°F to 104°F) and avoid relative humidity conditions in excess of 60%.
- Fill the reducer full with oil that is compatible with the product normally used or recommended during service.
- Apply grease to all unpainted or unprotected shafts, bores, keyways, flange surfaces, tapped holes, and to the exterior of all oil seals.
- Store in a location free from shock and vibration, to avoid false brinelling of bearing elements and raceways.
- Once every few months rotate the input shaft approximately 10-20 revolutions to redistribute the weight of gears and shafts and to prevent brinelling of the bearings and drying of the seal track.
- Avoid direct exposure to the sun or UV light and aggressive or corrosive materials in the environment (ozone, gases, solvents, acids, caustic solutions, salts, radioactivity, etc.)

## Commissioning After Long-Term Storage

- Please check your gear unit for a vent and if applicable to your product, remove the sealing plug to activate.

### NOTICE:

To prevent build-up of excessive pressure, sealed vents must be activated as shown prior to gear unit start up. Excessive pressure may cause damage to internal gearbox components and leakage.

- Remove all anti-corrosive metal protectant from otherwise bare metal surfaces. Follow product manufacturer's directions and warnings during surface protection removal.
- Drain the reducer and refill it with the proper type and amount of lubricant.
- Observe start-up and initial operation to make sure there are no seal or gasket leaks, or unusual sounds, vibration or heat rise during operation.
- Check the resistance of all motor and brake windings to verify the integrity of the winding insulation and inspect all terminal box openings and wire connection areas to verify that all components are dry and free of corrosion.

## Lubrication

Proper gearbox lubrication is essential in order to reduce friction, heat, and component wear. Lubricants reduce heat and wear by inserting a protective “fluid boundary” between mating parts and preventing direct metal to metal contact. Lubricants also help prevent corrosion and oxidation, minimize foam, improve heat transfer, optimize reducer efficiency, absorb shock loads and reduce noise. Most NORD reducers are shipped from the factory with a pre-determined oil fill level in accordance to the specified reducer size and mounting position.

The standard orientation for the gearbox is shown in Figure 12. The gearbox is filled with the correct amount of oil and is the correct configuration for this orientation. For any other orientation, please consult the factory.

Lubrication Table

ISO Viscosity	Oil Type	Ambient Temp Range (°F)	Brand	Pump Model: Standard Oil Shipped with Gearbox
<b>VG220</b>	<b>PAO-EP</b>	<b>-31 to 140</b>	<b>Mobil SHC Gear 220*</b>	<b>GNX(H)3, GNX(H)4</b>
<b>VG220</b>	<b>PAO</b>	<b>-31 to 140</b>	<b>Mobil SHC630*</b>	<b>GNX(H)2, GNX(H)2.5</b>
VG220	MIN-EP	32 to 104	Mobilgear 600XP220	
VG220	FG	23 to 104	Fuchs FM220	
VG460	PAO	-31 to 176	Mobil SHC 634	

\*Standard Oil Shipped with Gearbox

Oil Formulation Codes:

MIN-EP - Mineral Oil with EP Additive

PAO - Synthetic Polyalphaolefin Oil

PAO-EP – Synthetic Polyalphaolefin Oil with EP Additive

FG - Food-Grade Oil

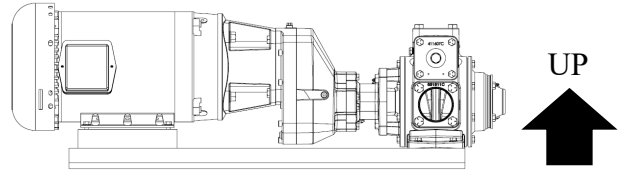

Figure 12 - Standard Gearbox Orientation

### NOTICE:

The “Ambient Temperature” is intended to be an operation guideline based upon the typical properties of all the lubricant. The viscosity and other properties of the lubricant change based upon load, speed, ambient conditions, and reducer operating temperatures. The user should consult with their lubrication supplier & NORD gear before considering changes in oil type or viscosity.

- To prevent reducer overheating, observe the maximum operating oil temperature limits:  
Mineral Oil: 176 – 180 °F  
Synthetic Oil: 225 °F
- In the following instances, please consult NORD for specific recommendations:
  - Gear units will operate in high ambient temperature conditions exceeding 40 oC (104 oF).
  - Gear units will operate in cold ambient temperature conditions approaching 0 oC (32 oF) or lower.
  - Lower than an ISO VG100 viscosity oil is being considered for a cold-temperature service.
  - Fluid grease is required for lubricating the gear unit.
- Observe the general lubrication guidelines outlined in user manual U10750.

### NOTICE:

Do not to mix different oils with different additive packages or different base oil formulation types. Polyglycol (PG) oils are not miscible with other oil types and should never be mixed with mineral oil or polyalphaolefin (PAO) synthetic oil.



# PUMP TROUBLESHOOTING

## NOTICE:

**Maintenance shall be performed by qualified technicians only, following the appropriate procedures and warnings as presented in this manual.**

Symptom	Probable Cause
<b>Pump Not Priming</b>	<ol style="list-style-type: none"> <li>1. Pump not wetted.</li> <li>2. Worn vanes</li> <li>3. Suction valve closed.</li> <li>4. Air leaks in the suction line.</li> <li>5. Strainer clogged.</li> <li>6. Suction line or valves clogged or too restrictive.</li> <li>7. Pump vapor-locked.</li> <li>8. Pump speed too low for priming.</li> <li>9. Relief valve partially open, worn or not seating properly.</li> </ol>
<b>Reduced Capacity</b>	<ol style="list-style-type: none"> <li>1. Pump speed too low.</li> <li>2. Suction valves not fully open.</li> <li>3. Air leaks in the suction line.</li> <li>4. Excessive restriction in the suction line (undersized piping, too many elbows &amp; fittings, clogged strainer, etc.).</li> <li>5. Damaged or worn parts.</li> <li>6. Excessive restriction in discharge line causing partial flow through the relief valve.</li> <li>7. Relief Valve worn, set too low, or not seating properly.</li> <li>8. Vanes installed incorrectly (see "Vane Replacement").</li> </ol>
<b>Noise</b>	<ol style="list-style-type: none"> <li>1. Excessive vacuum on the pump due to:               <ol style="list-style-type: none"> <li>a. Undersized or restricted fittings in the suction line.</li> <li>b. Pump speed too fast for the viscosity or volatility of the liquid.</li> <li>c. Pump too far from fluid source.</li> </ol> </li> <li>2. Running the pump for extended periods with a closed discharge line.</li> <li>3. Pump not securely mounted.</li> <li>4. Bearings worn or damaged.</li> <li>5. Vibration from improperly anchored piping.</li> <li>6. Bent shaft, or drive coupling misaligned.</li> <li>7. Excessively worn rotor.</li> <li>8. Malfunctioning valve in the system.</li> <li>9. Relief valve setting too low.</li> <li>10. Damaged vanes (see following category).</li> <li>11. Vanes installed incorrectly (see "Vane Replacement").</li> </ol>
<b>Damaged Vanes</b>	<ol style="list-style-type: none"> <li>1. Foreign objects entering the pump.</li> <li>2. Running the pump dry for extended periods of time.</li> <li>3. Cavitation.</li> <li>4. Viscosity too high for the vanes and/or the pump speed.</li> <li>5. Incompatibility with the liquids pumped.</li> <li>6. Excessive heat.</li> <li>7. Worn or bent push rods, or worn push rod holes.</li> <li>8. Settled or solidified material in the pump at start-up.</li> <li>9. Hydraulic hammer - pressure spikes.</li> <li>10. Vanes installed incorrectly (see "Vane Replacement").</li> </ol>
<b>Broken Shaft</b>	<ol style="list-style-type: none"> <li>1. Foreign objects entering the pump.</li> <li>2. Viscosity too high for the pump speed - EC Rotor &amp; Shaft required for fluid viscosities over 20,000 SSU.</li> <li>3. Relief valve not opening.</li> <li>4. Hydraulic hammer - pressure spikes.</li> <li>5. Pump/driver misalignment.</li> <li>6. Excessively worn vanes or vane slots.</li> <li>7. Settled or solidified material in the pump at start-up.</li> </ol>
<b>Mechanical Seal Leakage</b>	<ol style="list-style-type: none"> <li>1. O-rings not compatible with the liquids pumped.</li> <li>2. O-rings nicked, cut or twisted</li> <li>3. Shaft at seal area damaged, worn or dirty.</li> <li>4. Ball bearings overgreased.</li> <li>5. Excessive cavitation.</li> </ol>

6. Mechanical seal faces cracked, scratched, pitted or dirty.

## GEAR REDUCER TROUBLESHOOTING

### NOTICE:

**Maintenance shall be performed by qualified technicians only, following the appropriate procedures and warnings as presented in this manual.**

This section identifies some of the most common issues involved with NORD Gear speed reducers, and provides recommendations to assist you in defining and answering your questions as you work with our products. You may also contact our Engineering/Application departments if your questions are not answered in the table below.

Problem With the Reducer		Possible Causes	Suggested Remedy
Runs Hot	Overloading	Load exceeds the capacity of the reducer	Check rated capacity of reducer, replace with unit of sufficient capacity or reduce the load.
	Improper lubrication	Insufficient lubrication	Check lubricant level and adjust up to recommended levels
		Excessive lubrication	Check lubricant level and adjust down to recommended levels.
		Wrong lubrication	Flush out and refill with correct lubricant as recommended
Runs Noisy	Loose foundation bolts	Weak mounting structure	Inspect mounting of reducer. Tighten loose bolts and/or reinforce mounting and structure.
		Loose hold down bolts	Tighten bolts
	Failure of bearings	May be due to lack of lubricant	Replace bearing. Clean and flush reducer and fill with recommended lubricant.
		Overload	Check rated capacity of reducer.
	Insufficient lubricant	Level of lubricant in reducer not properly maintained.	Check lubricant level and adjust to factory recommended level.
Output shaft does not turn	Internal parts are broken or missing	Overloading of reducer can cause damage	Replace broken parts. Check rated capacity of reducer.
		Key missing or sheared off on input shaft.	Replace key.
		Coupling loose or disconnected	Properly align reducer and coupling. Tighten coupling.
Oil Leakage	Worn seals	Caused by dirt or grit entering seal.	Replace seals. Autovent may be clogged. Replace or clean.
	Unit runs hot or leaks	Overfilled reducer	Check lubricant level and adjust to recommended level.
		Vent clogged.	Clean or replace, being sure to prevent any dirt from falling into the reducer.
	Incorrect fill level	Improper mounting position, such as wall or ceiling mount of horizontal reducer.	Check mounting position on the name tag & verify with mounting chart in manual.

**Blackmer**<sup>®</sup>

1809 Century Avenue, Grand Rapids, Michigan 49503-1530 U.S.A.  
Telephone: (616) 241-1611 • Fax: (616) 241-3752  
E-mail: [blackmer@blackmer.com](mailto:blackmer@blackmer.com) • Internet: [www.blackmer.com](http://www.blackmer.com)